



www.boztibbi.com
boz@boztibbi.com

Product Catalogue



Boz Medical Device Industry and Trade Inc.

Boz Medical Device Industry and Trade Inc. is founded by Adil Boz and Ali Aykut Boz in August of 2009 in Ankara. Common grandfather Adil Boz and father Orhan Boz of the founders are one of the oldest people in health sector in Turkey.

Adil Boz (Grandfather) began his trade life in 1940s. He founded a small family company, began to produce the gauze in 1960s, plaster of paris bandage and absorbent cotton in 1970's to the health sector. He is the one of oldest medical device producer of Türkiye. The company founded by Adil Boz located in Uşak, produced integratedly from raw cotton to the yarn; from yarns to the woven; woven textile raw materials, home and hospital textile fabrics and provided job oppornuties to 1500 people in its facilities.

Orhan Boz founded a company that gives his own name in 1983, and has begun to his trade life with selling product of gauze, plaster of paris bandage and absorbent cotton that is produced by Adil Boz in Uşak. After noticing lack of the surgical suture goods, in 1993 he has begun to trial production after set up factory for the purpose of producing surgical sutures with the name of ORHAN BOZ MEDICAL DEVICE CO. In year of 1998 he manufactured the products of gauze compress, sponge, cotton pad, gauze roll that are produced from gauze. Boz family, since they have gone into the bussine life in Republic of Turkiye, created a competitive enviroment against the a lot of international companies and has played a important role in our natioal interests.

In 2009, Boz Medical Device Industry and Trade Inc. founded by Ali Aykut Boz and Adil Boz, has aimed in accordance with emerging market needs and conditions to be in position of manufacturer and has achived its goal in month of April of 2012.

The factory established in Ankara, has 8600 m2 closed areas and 1200 m2 clean rooms. In the facility has equipped with modern climate system, the white areas are the level of class III. The minimum requirements in production, is executed prepared towards the World Health Organization's (WHO) proposed principles and published "Good Production Applications" by T.C. Ministry of Health. Rigor and Hygenic are essential at all level of Production.

Needle Information & Use of Surgical Needles 1

Tip Shapes According to Lengths	2
Needle Point Profiles	3
Needle Shapes According to Lengths	4 - 8
Angle of Needles & Needle Shape	9
Comparison of Suture Size	10
Use of Needle Holders	11

Packaging & Labelling Information 12-13

Suture Labelling Guide	14
Packaging & Labelling Information	15
Multi - Lingual Symbols	16
Package Types	17
Comparison of Suture Size	18

Absorbable Sutures 19

Glikosorb <small>Surgical Suture, Polyglycolicacid (PGA) Absorbable,Synthetic,Braided</small>	20-33
Glikolak <small>Surgical Suture, Poly(glycolide(90%)-co-lactide(10%))(PGLA)Absorbable,Synthetic,Braided</small>	34-43
Fastsorb <small>Surgical Suture, Polyglycolicacid (PGA) Fast Absorbable,Synthetic,Braided,Undyed</small>	44-49
Fastlak <small>Surgical Suture, Poly(glycolide(90%)-co-lactide(10%))(PGLA) Fast Absorbable,Synthetic,Braided,Undyed</small>	50-55
Monokaprol <small>Surgical Suture, Poly(glycolide(75%)-co-caprolactone (25%))(PGCL) Absorbable, Synthetic, Monofilament</small>	56-61
Polidiox <small>Surgical Suture, Polydioxanone (PDO) Absorbable, Synthetic, Monofilament, Violet</small>	62-67

Antibacterial Absorbable Sutures 68

Glikosorb Plus <small>Surgical Suture, Polyglycolicacid (PGA) Absorbable,Synthetic,Braided</small>	69-77
Glikolak Plus <small>Surgical Suture, Poly(glycolide(90%)-co-lactide(10%))(PGLA)Absorbable,Synthetic,Braided</small>	78-86
Monokaprol Plus <small>Surgical Suture, Poly(glycolide(75%)-co-caprolactone(25%))(PGCL)Absorbable, Synthetic, Monofilament</small>	87-92
Polidiox Plus <small>Surgical Suture, Polydioxanone (PDO) Absorbable, Synthetic, Monofilament</small>	93-96

Contents

Absorbable Sutures

97

Plain Catgut Absorbable Surgical Suture 98-106

Chromic Catgut Absorbable Surgical Suture 107-116

Non - Absorbable Sutures

117

Silk Surgical Suture, Silk, Silicone Coated Nonabsorbable, Noncapillary 118-128

Monoprolen Surgical Suture, Polypropylene (PP) Nonabsorbable, Synthetic, Monofilament 129-141

Monoflorid Surgical Suture, Poly (vinylidene difluoride) (PVDF) Nonabsorbable, Synthetic, Monofilament 142-147

Monamid Surgical Suture, Monofilament Polyamide (PA) Nonabsorbable, Synthetic 148-154

Multamid Surgical Suture, Multifilament Polyamide (PA) Silicone Coated Nonabsorbable, Synthetic 155-157

Polisil Surgical Suture, Braided Polyester, Silicone Coated (PET) Nonabsorbable, Synthetic 158-165

Monotef Surgical Suture, Polytetrafluoroethylene (PTFE) Nonabsorbable, Synthetic, Monofilament 166-169

Polytef Surgical Suture, Braided Polyester, (PTFE) Coated Nonabsorbable, Synthetic 170-171

Monowire Surgical Stainless Steel Wire Nonabsorbable, Monofilament or Multifilament 172-174

Tempowire Surgical Stainless Steel Wire Nonabsorbable, Multifilament 175-177

PTFE pledget

178-179

Absorbable Haemostats

180

Reoxcel Oxidized Regenerated Cellulose (ORC) 181

Reoxcel - Sigma Knit Oxidized Regenerated Cellulose (ORC) 182

Reoxcel - Fibril Oxidized Regenerated Cellulose (ORC) 183

Zeocel Oxidized Cellulose (OC) 184

Specialist Products	185
Microsurgery Products	186
Polyethylene Oval Retention Plate	187
Polypropylene Buttressing Button	188
Polypropylene Locking Button	189
Polypropylene Bead - Aluminum Ring	190

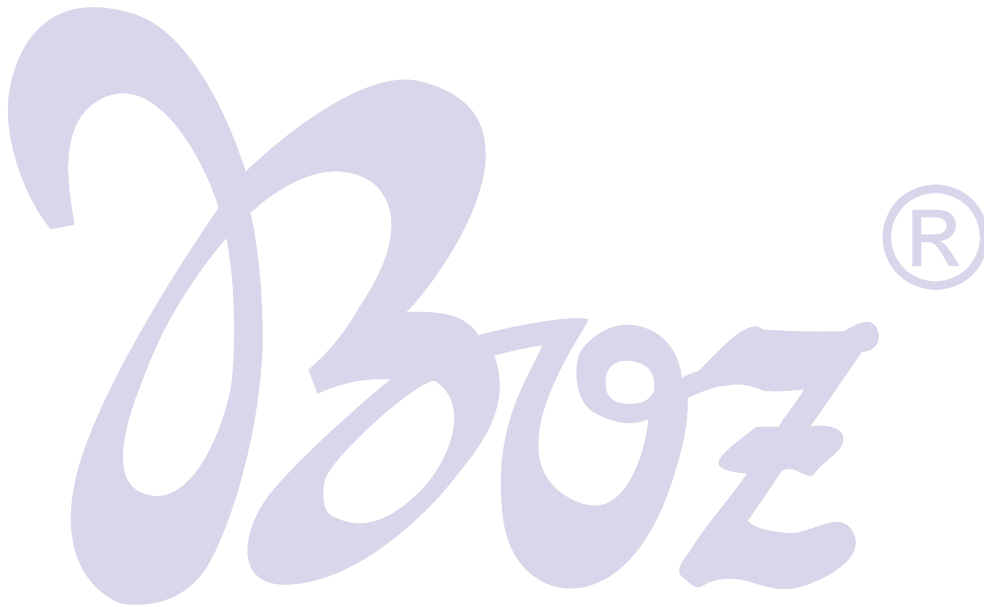

Needle Information & Use of Surgical Needles

- Taper Point
- Square Body, Taper Point
- Blunt
- Reverse Cutting
- Inside Cutting
- Diamond
- Spatula
- Lancet
- CC Needle
- Tapercutting
- Trocar
- Square Body Tapercutting



Tip Shapes According to Lengths

Round Body, Taper Point

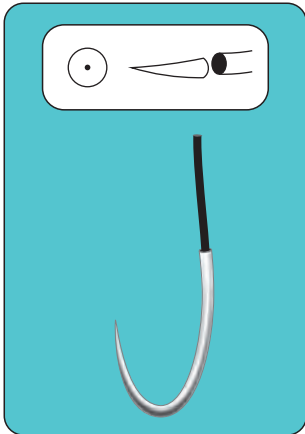

Doesn't have a cutting edge. Has a conic body becoming sharp towards its tip. Is used in tissues showing low resistance to the needle.

Square Body, Taper Point

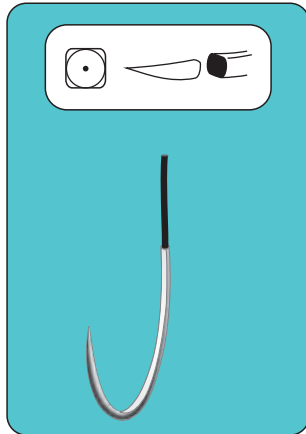

Doesn't have a cutting edge. Has a conic body becoming sharp towards its tip. In order to strengthen the body of the needle, the body is given a square shape.

Blunt

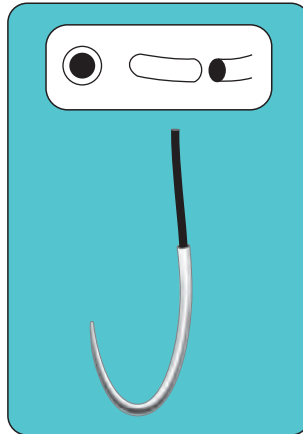

Doesn't have a property of cutting and drilling. Is used in parenchyma tissues that can be easily damaged like liver and kidney.

Reverse Cutting

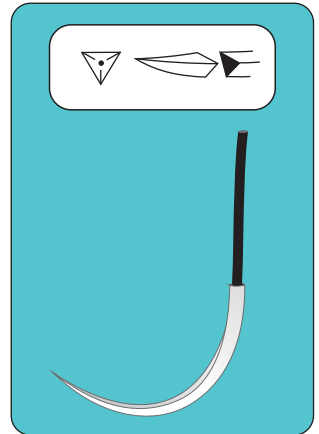

Reverse (Outside apex) cutting needle has cutting edges at the bottom and in its two sides, becomes sharp towards its tip and has triangular point.

Inside Cutting

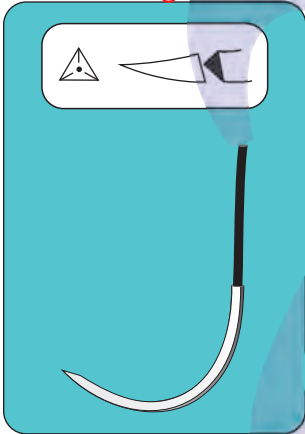

Inside (Inside apex) cutting needle has cutting edges at the top and in its two sides, becomes sharp towards its tip and has triangular point.

Diamond



This needle has a keen tip. It angled conically towards the needle body. It's generally used in hard tissues.

Spatula

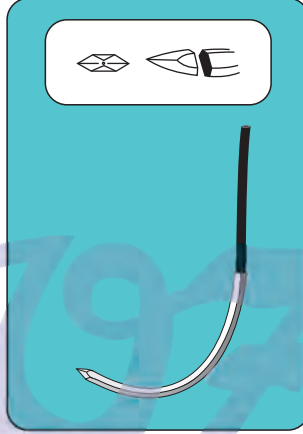

This needle is flat and become thinner towards its tip. It's especially used in ophthalmic surgery.

Lancet

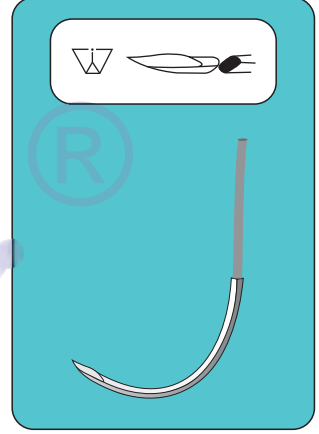

Its structure looks like spatulated needle. However, its tip isn't parallel but oblique to its body. Edges of its top are sharp. It's generally used in ophthalmic surgery.

CC Needle

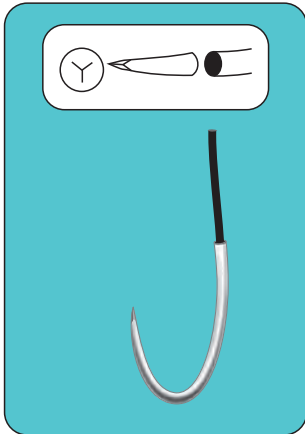

It combines the properties of round and cutting needles. Three cutting edges of the needle does not combine with the round body. Sharp edges have single cutting type.

Tapercutting

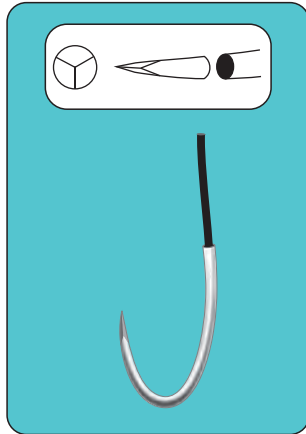

Combine the features of the reverse cutting edge tip and taper point needles. Three cutting edges extend from the point. These blend into a round taper body. All three edges are sharpened to provide uniform cutting action.

Trocar

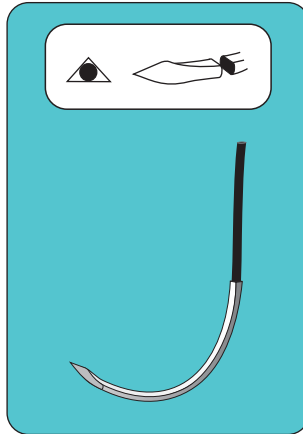





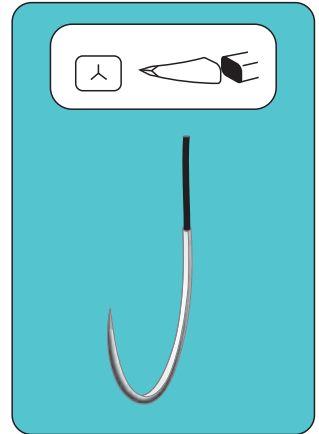











Trocar needle has a strong cutting tip. The tip of the needle have been designed for penetration of the even dense tissues.

Square Body Tapercutting



In order to strengthen the body of the tapercutting needle, the body is given a square shape.

Needle Point Profiles

Taper Point		<p>Doesn't have a cutting edge. Has a conic body becoming sharp towards its tip. Is used in tissues showing low resistance to the needle.</p>
Square Body, Taper Point		<p>Doesn't have a cutting edge. Has a conic body becoming sharp towards its tip. In order to strengthen the body of the needle, the body is given a square shape.</p>
Blunt		<p>Doesn't have a property of cutting and drilling. Is used in parenchyma tissues that can be easily damaged like liver and kidney.</p>
Reverse Cutting		<p>Reverse (Outside apex) cutting needle has cutting edges at the bottom and in its two sides, becomes sharp towards its tip and has triangular point.</p>
		<p>This reverse cutting needle is handhoned and has a long tip. Generally it's used in plastic surgery.</p>
		<p>Compared to premium needle, it's more grinded and sharp. Generally it's used in plastic surgery.</p>
Inside Cutting		<p>Inside (Inside apex) cutting needle has cutting edges at the top and in its two sides, becomes sharp towards its tip and has triangular point.</p>
		<p>This cutting edge needle is handhoned and has a long tip. Generally it's used in plastic surgery.</p>
		<p>Compared to premium needle, it's more grinded and sharp. Generally it's used in plastic surgery.</p>
Diamond		<p>This needle has a keen tip. It angled conically towards the needle body. It's generally used in hard tissues.</p>
		<p>It's handhoned.</p>
Spatula		<p>This needle is flat and become thinner towards its tip. It's especially used in ophthalmic surgery.</p>
Lancet		<p>It's structure looks like spatulated needle. However, its tip isn't parallel but oblique to its body. Edges of its top are sharp. It's generally used in ophthalmic surgery.</p>
CC Needle		<p>It combines the properties of round and cutting needles. Three cutting edges of the needle does not combine with the round body. Sharp edges have single cutting type.</p>
Tapercutting		<p>Combine the features of the reverse cutting edge tip and taper point needles. Three cutting edges extend from the point. These blend into a round taper body. All three edges are sharpened to provide uniform cutting action.</p>
Trocar		<p>Trocar needle has a strong cutting tip. The tip of the needle have been designed for penetration of the even dense tissues.</p>
Square Body Tapercutting		<p>In order to strengthen the body of the tapercutting needle, the body is given a square shape.</p>

Needle Shapes According to Lengths

Taper Point



1/2

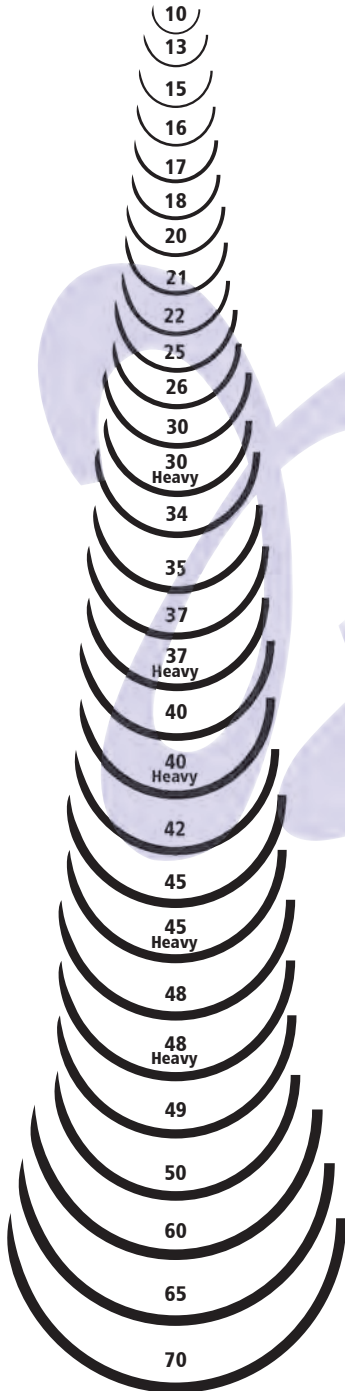

3/8

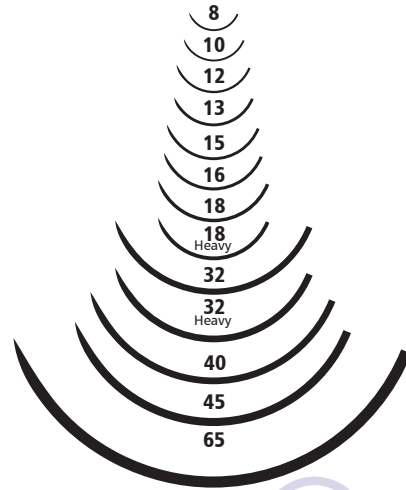

5/8

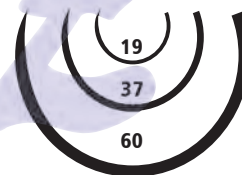

Düz /
Straigh

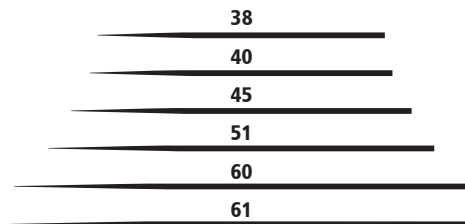

Needle Shapes According to Lengths

Square Body, Taper Point



1/2

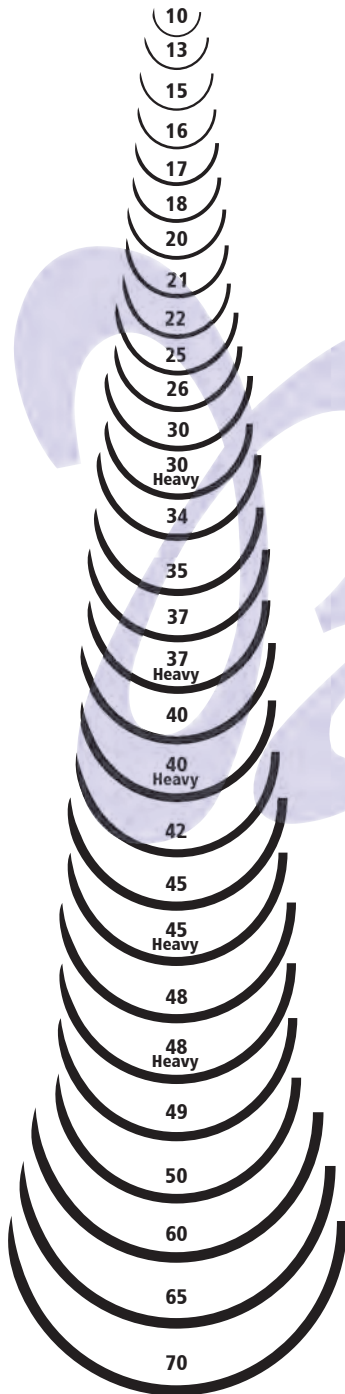

3/8

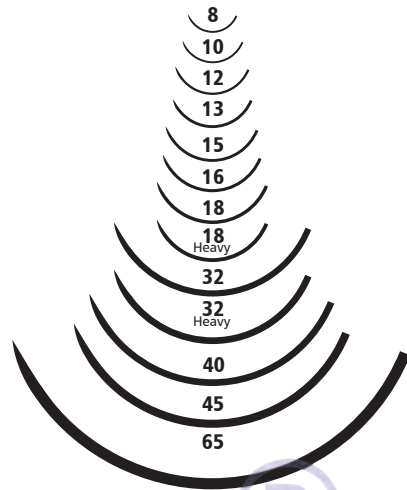

5/8

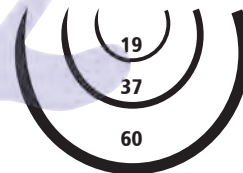

Düz /
Straigth

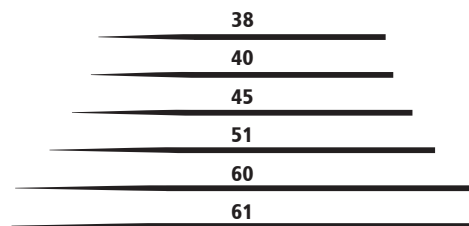

Needle Shapes According to Lengths

Reverse Cutting

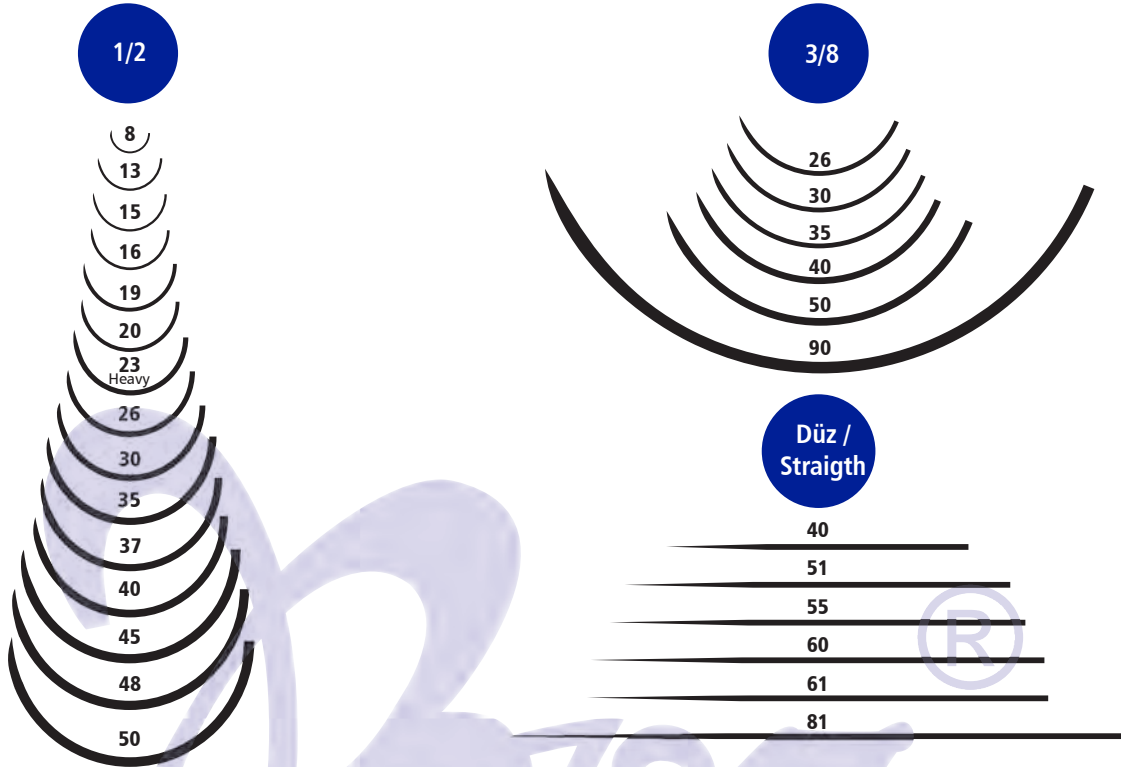

Inside Cutting

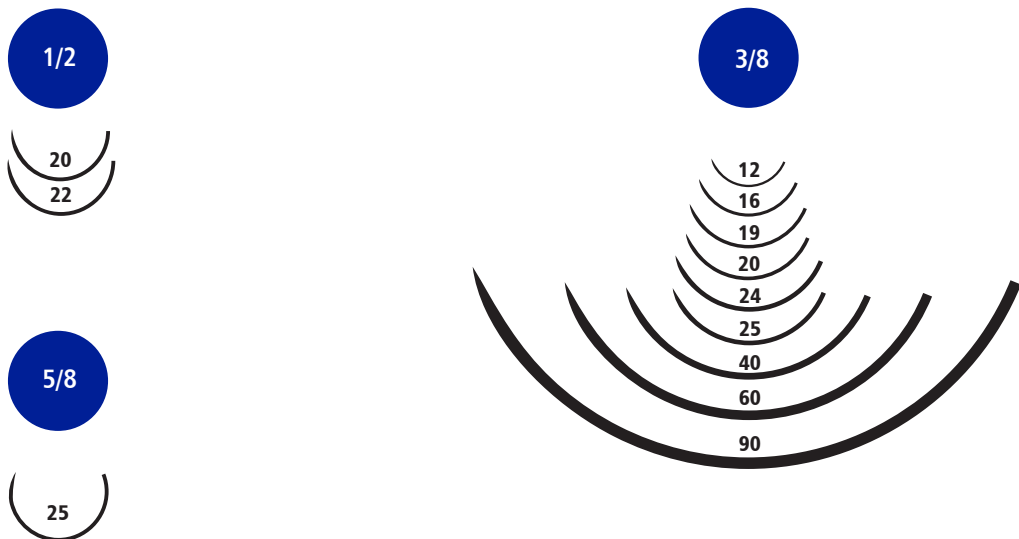

Needle Shapes According to Lengths

Diamond



1/2

3/8

Düz /
Straigth

25

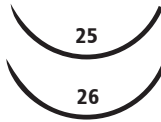
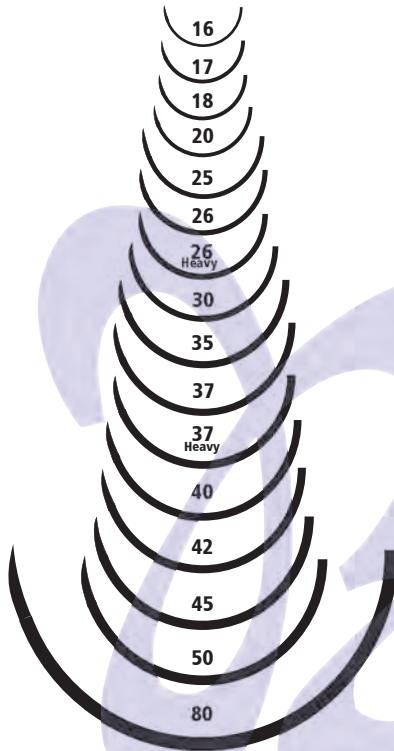

Blunt



3/8

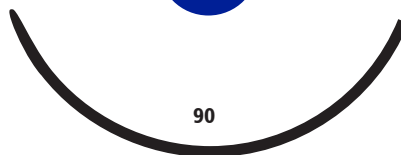

90

Needle Shapes According to Lengths

Tapercutting

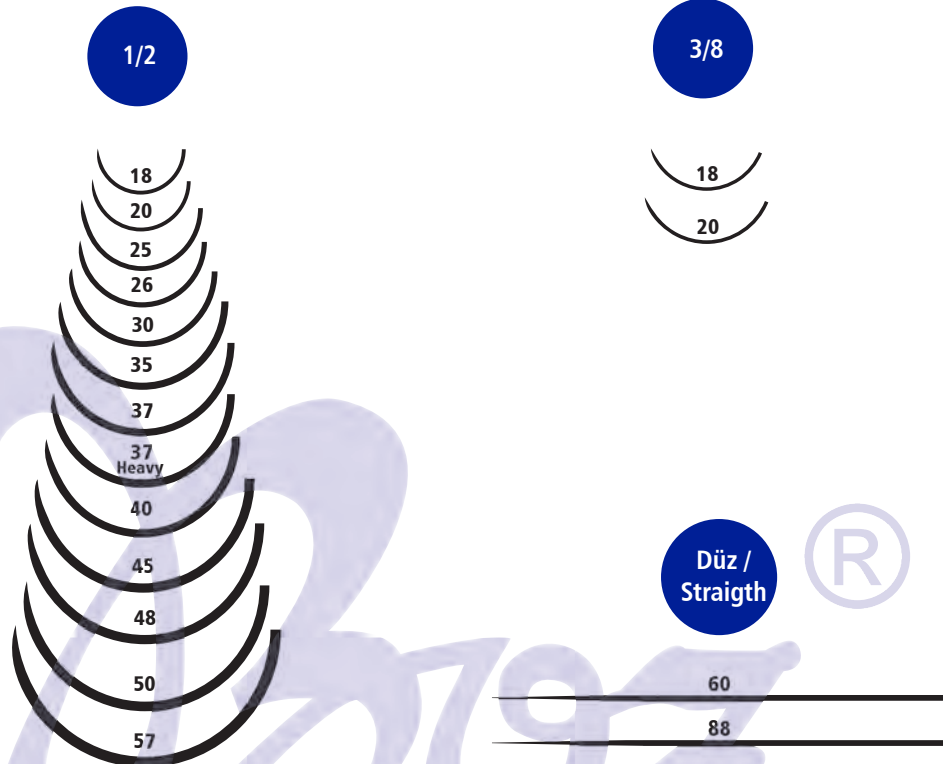

Spatula

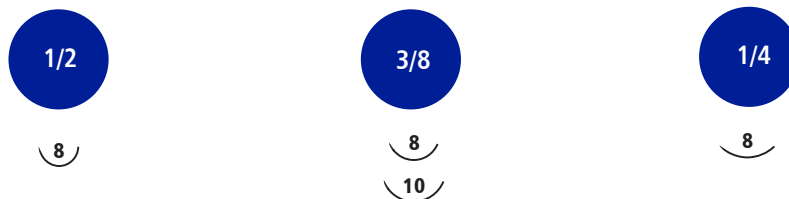

Angle of Needles & Needle Shape

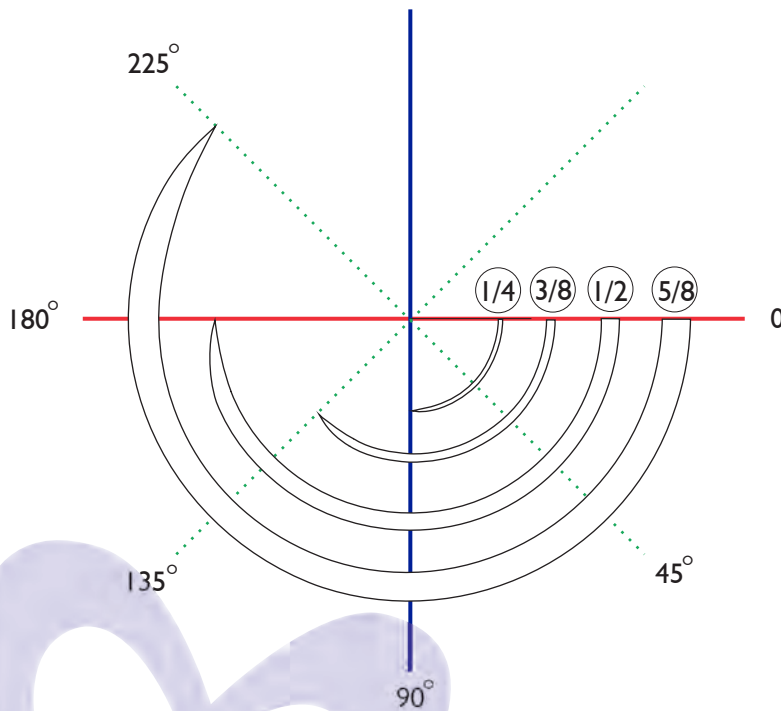

The choice of needle shape is frequently governed by the accessibility of the tissue to be sutured, and normally the more confined the operative site the greater the curvature required. The basic shapes involved are:

1/4 Circle

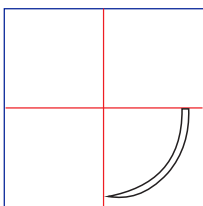

3/8 Circle

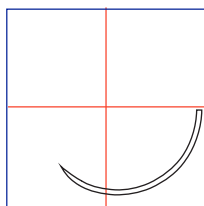

1/2 Circle

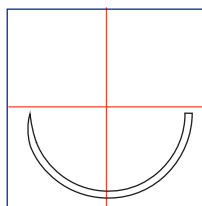

5/8 Circle

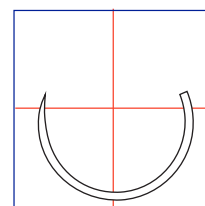

J Shape

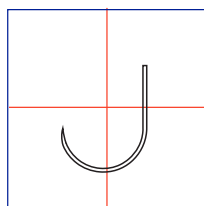



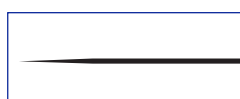









Straight



Comparison of Suture Size













A

USP values are stated for the non-absorbable mono and multiflament, absorbable multiflament sutures in the columns under A.

USP	Metric	Suture Diameter, mm	% reduction
3	6	 0.600-0.699	
2	5	 0.500-0.599	28
1	4	 0.400-0.499	33
0	3.5	 0.350-0.399	30
2/0	3	 0.300-0.349	25
3/0	2	 0.200-0.249	43
4/0	1.5	 0.150-0.199	40
5/0	1	 0.100-0.149	50
6/0	0.7	 0.070-0.099	53
7/0	0.5	 0.050-0.069	49
8/0	0.4	 0.040-0.049	42
9/0		 0.030-0.039	
10/0		 0.020-0.029	

B

USP values are stated for the monofilament absorbable sutures in the columns under B.

USP	Metric	Suture Diameter, mm	% reduction
3		 0.600-0.699	
2	5	 0.571-0.610	
1	4	 0.500-0.570	18
0	3.5	 0.400-0.499	30
2/0	3	 0.340-0.399	32
3/0	2	 0.250-0.339	37
4/0	1.5	 0.200-0.249	35
5/0	1	 0.150-0.199	40
6/0	0.7	 0.095-0.149	52
7/0	0.5	 0.050-0.094	66
8/0		 0.040-0.049	
9/0		 0.030-0.039	
10/0		 0.020-0.029	

Use of Needle Holders

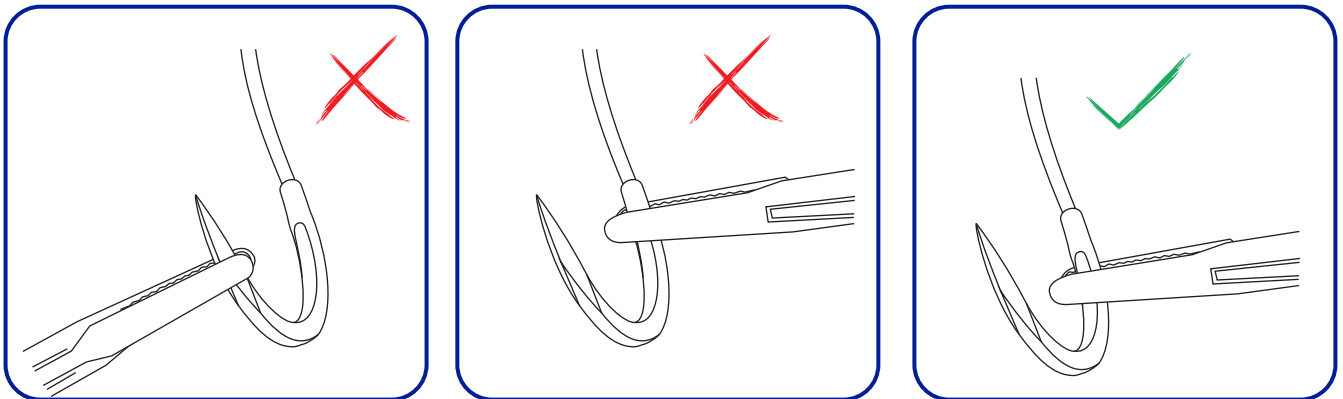

1- The needle holder should be carefully selected to match the size and strength of the needle to be used. The use of a needle holder larger than required can result in damage to the needle and in particular, distortion of the curvature.

2- The needle holder should be in good condition as worn jaws can result in needle rotation and instability in the needle holder. Nicks or defects in the needle holder jaws can also cause damage to the needle and loss of strength.

3- Needles should be grasped securely on the tip of the needle holder jaws.

4- Needles should only be held in the flattened area provided and should not be grasped on the attachment area or near to the needle point. Needles which are not flatted should be grasped for placement at a point approximately one third of the needle length from the butt. Excessive force should not be applied when gripping the needle, particularly with Tungsten Carbide jaw inserts, as this may damage the needle body and cause loss of strength or breakage.

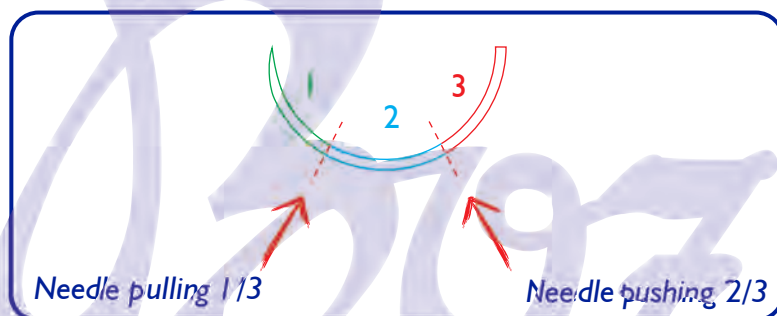

Use of Surgical Needles

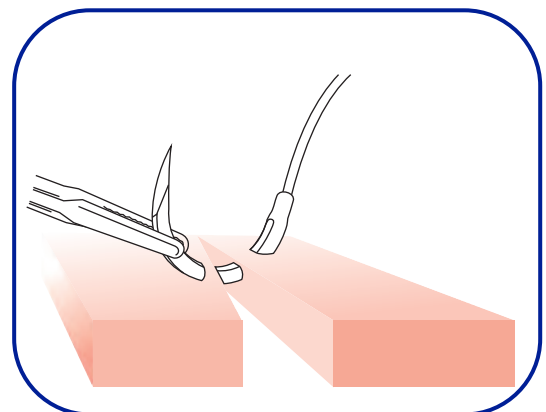
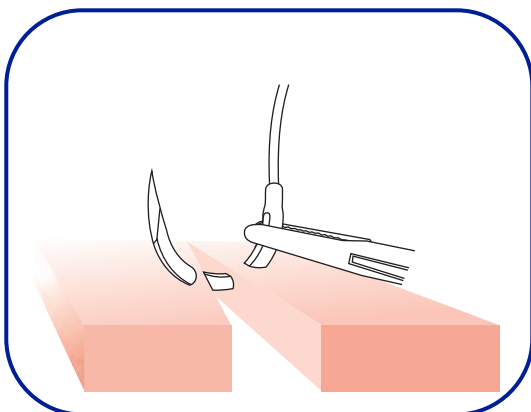

- 1- The force required to achieve passage of the needle through tissue should be applied in a direction following the curvature of the needle.
- 2- Care should be taken to match the size of the needle to the size of tissue bite required. The use of too small a needle for a given tissue bite can lead to bending.
- 3- Should the placement of the needle in tissue require to be readjusted, the needle should be removed and re-inserted. No attempt should be made to twist the needle in tissue.
- 4- The needles should normally be inserted separately into each side of the tissue to be approximated and should not be used to bridge a wound.

Packaging & Labelling Information

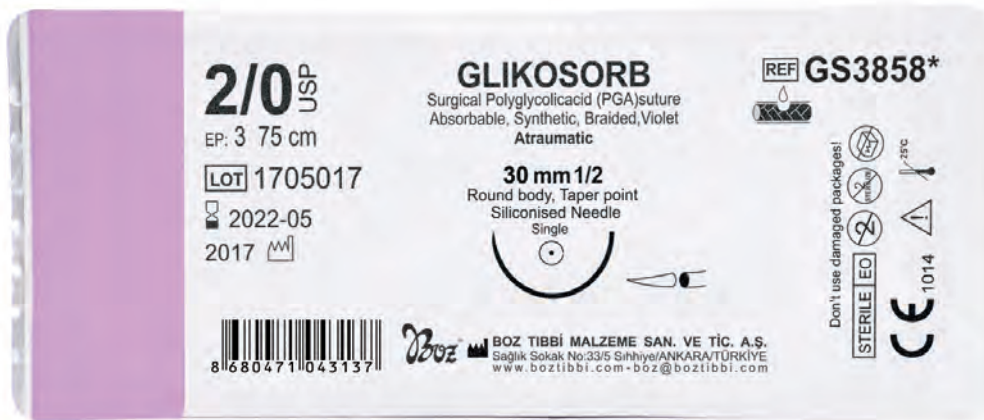

Packaging & Labelling Information



Suture Labelling Guide

Box Label

Manufacturer

Multi-Lingual Symbols
Dyed, Absorbable, Braided, Coated

LOT
Batch Number.

YYYY-MM
Date of expiry.

YYYY
Date of manufacture.

STERILE EO
Sterile Product-Method of Sterilization-Ethylene Oxide.

Material gauge USP.

Material gauge metric.

Material length.

Material type and description.

Ref
Product catalogue (Code) number.

Needlepoint slide view,
Round body, Taper point

Needle shape: 1/2 c. etc. and; length.
Double needle shows double armed.

Tree dimensional view of the needle point.

1014
Notified Body number.

Do not reuse.

Do not re-sterilize

Do not use if package is damaged

Attention, See instruction for use

CE 1014
Marking of conformity.

Store below 25 °C.

Sachet Label

Material type and description.

Material gauge USP.

Material gauge metric.

LOT
Batch Number.

YYYY-MM
Date of expiry.

YYYY
Date of manufacture.

Product barcode

Needle shape: 1/2 c. etc. and; length.
Double needle shows double armed.

Needlepoint slide view,
Round body, Taper point

Manufacturer

REF
Product catalogue (Code) number.

Multi-Lingual Symbols
Dyed, Absorbable, Braided, Coated

Do not use if package is damaged

Store below 25°C.

Do not re-sterilize

Attention, See instruction for use

1014
Notified Body number.

CE 1014
Marking of conformity.

Tree dimensional view of the needle point.

Do not reuse.

STERILE EO
Sterile Product-Method of Sterilization-Ethylene Oxide.

Packaging

Sutures are packed in one or two / three dozen boxes.
Boxes are designed for easy usage and environmental friendly have been.
Box labels are colour coded for easy suture type defining.
Pealable double blister is the individual package.
Blister consists of transparent polyethylene film and medical grade of paper.
Paper is coloured with Ethylene Oxide (EO) indicator; yellow colour proves the product processed in EO gas.

Labelling

The Following symbols(from European Standard En980) are used on our labelling

- On each product and box; type of the suture, USP and EP size, needle length and following signs are stated.

Certificates Labelling



CE-mark and identification number of notified body. Product conforms to the essential requirements of the Medical Device Directive 93/42/EEC



Medical Device Directive Labelling

- The following symbols (from European Standard EN980) are used on our labelling.



Do not reuse.



YYYY - MM

Use until year and month.



Sterile Product-Method of Sterilization-Ethylene Oxide.



Sterile Product-Method of Sterilization-Irradiation.



Batch Number



Attention, See instruction for use



Marking of Conformity. Notified Body number.

Additional Labelling

- For reordering products are defined by code numbers.



Product Catalogue (Code) Number.

- To supply easy informing needle shape is clearly defined by drawings.



Needlepoint side view, cutting edge, taper etc.



Three dimensional view of the needle point.



Needle shape: 1/2 c. etc. and; length. Double needle shows double armed.

Multi - Lingual Symbols

The European Association of Surgical Suture Industry has developed a system of symbols which is designed to describe various suture product characteristics in an intuitive, pictorial manner. The use of symbols is permitted by the Medical Device Directive and enables companies to provide information to the customer without having to provide multilingual translations.

Symbol	Description	Example Product
	Dyed, Absorbable, Braided, Coated	GLIKOLAK, GLIKOSORB, <i>Antibacterial</i> GLIKOLAK Plus, <i>Antibacterial</i> GLIKOSORB Plus
	Dyed, Absorbable, Monofilament	MONOKAPROL, POLIDIOX, <i>Antibacterial</i> MONOKAPROL Plus, <i>Antibacterial</i> POLIDIOX Plus
	Dyed, Non-absorbable, Braided, Coated	SILK, MULTAMID, POLISIL, POLYTEF
	Dyed, Non-absorbable, Monofilament	MONOPROLEN, MONOFLORID, MONAMID
	Dyed, Non-absorbable, Twisted, Coated	SILK
	Undyed, Absorbable, Braided, Coated	FASTLAK, FASTSORB, GLIKOLAK, <i>Antibacterial</i> GLIKOLAK Plus
	Undyed, Absorbable, Monofilament	MONOKAPROL, <i>Antibacterial</i> MONOKAPROL Plus
	Undyed, Non-absorbable, Braided, Coated	SILK
	Undyed, Non-absorbable, Monofilament	MONAMID, MONOTEF, MONOWIRE
	Undyed, Non-absorbable, Twisted, Coated	SILK, TEMPOWIRE
	Undyed, Non-absorbable Twisted	

Dozen Box



Standard individual package is a dozen box.
Twelve of sachets are put in drawer box, than the box is labelled.



Double or triple dozen boxes are used for packaging of 24/36 sachets on request.

Long Boxes



To avoid bending, monofilament stainless steel wires are put in individual envelopes which are as long as suture length. Then they are boxed in long boxes at the same size.

Shipping Container



Depending on order quantity boxes are put in containers which can store 40/60 or 100 standard boxes.

All boxes are preshrinked before packaging.



Comparison of Suture Size

Box Label

ORDER NO : ①		###		
COMPANY NAME : ②		XXX		
CITY : ③		XXX		
USP	CATALOG NO	TYPE	LOT NO. ④	AMOUNT
2/0	GS3858	GLIKOSORB 30 mm	1705017	100 ⑤
—	—	—	—	—
				100 ⑥
⑦ PERFORMER				

Each parcel is labelled with a sticker. This label defines the integrity of the parcel including order references.

- ① Order number given by manufacturer, refer to order history record.
- ② Company who ordered.
- ③ Destination: city if inland, country if abroad.
- ④ USP/Catalogue/Lot numbers and Type of the enclosed product/products.
- ⑤ Amount of each item enclosed, in dozen.
- ⑥ Total amount of enclosed products, in dozen.
- ⑦ Person who prepared parcel.



Boz Medical Device Industry and Trade Inc.

Absorbable Sutures

GLIKOSORB

GLIKOLAK

FASTSORB

FASTLAK

MONOKAPROL

POLIDIOX

web : www.boztibbi.com
email: boz@boztibbi.com

Surgical Sutures Absorbable

Glikosorb

Surgical Suture, Polyglycolicacid (PGA) Absorbable, Synthetic, Braided

Boz®



Definition

Synthetic absorbable, coated, mid term wound support and mid term mass absorption.

Material

Polyglycolic Acid (PGA)

Coating

Calcium Stearate and polycaprolactone

Structure

Braided - Multifilament

Colour

Violet (dyed) or Beige (undyed)

Size

EP : 0.4 to 8

USP : 8/0 to 6

Tensile Strength Retention

2. Week 75 % - 3. Week 50 %

Mass Absorption

60-90 days

Sterilization Method

Ethylene Oxide Gas

Main Indication

Gastrointestinal Surgery

Gynaecology

Ophthalmic Surgery

Orthopedics





Urology





Skin closer - intracutaneous, subcutaneous.













Ligatures

Glikosorb

Surgical Suture, Polyglycolicacid (PGA) Absorbable, Synthetic, Braided

Needle Length and description	Product No	USP EP	Length (cm)	Unit Pcs	Color	
6 mm						
3/8 Spatula 220 Micron	 	GS5401	8/0 0,4	45	12	Violet
3/8 Spatula 230 Micron	 	GS1156	8/0 0,4	45	12	Violet
		GS1252	7/0 0,5	30	12	Violet

6,6 mm						
1/2 Cobra 230 Micron	 	GS5519	8/0 0,4	60	12	Violet
1/2 Cobra 280 Micron	 	GS5518	7/0 0,5	60	12	Violet

8 mm						
1/2 Spatula 230 Micron	 	GS1193	8/0 0,4	30	12	Violet
		GS1195	8/0 0,4	45	12	Violet
1/2 Spatula 330 Micron	 	GS1272	7/0 0,5	45	12	Violet
		GS1395	6/0 0,7	45	12	Violet
1/2 Spatula 340 Micron	 	GS5526	5/0 1,0	45	12	Violet
1/4 Spatula 230 Micron	 	GS1190	8/0 0,4	45	12	Violet
1/4 Spatula 250 Micron	 	GS5876	7/0 0,5	45	12	Violet
1/4 Spatula 340 Micron	 	GS1268	7/0 0,5	45	12	Violet
		GS1404	6/0 0,7	30	12	Violet
		GS1405	6/0 0,7	45	12	Violet
		GS1406	6/0 0,7	45	12	Undyed
		GS1764	5/0 1,0	45	12	Violet

Glikosorb

Surgical Suture, Polyglycolicacid (PGA) Absorbable, Synthetic, Braided

Needle Length and description	Product No	USP EP	Length (cm)	Unit Pcs	Color	
8 mm						
1/4 Spatula 430 Micron	 	GS2362	4/0 1,5	45	12	Violet
1/4 Spatula 430 Micron	 	GS2363	4/0 1,5	45	12	Violet
3/8 Round Body, Taper Point 230 Micron	 	GS1207	8/0 0,4	30	12	Violet
3/8 Round Body, Taper Point 280 Micron	 	GS1413	6/0 0,7	45	12	Violet
		GS1426	6/0 0,7	45	12	Violet
		GS1768	5/0 1,0	45	12	Violet
10 mm						
3/8 Round Body, Taper Point 280 Micron	 	GS1480	6/0 0,7	75	12	Violet
3/8 Reverse Cutting 330 Micron	 	GS1496	6/0 0,7	45	12	Violet
3/8 Reverse Cutting 330 Micron	 	GS1492	6/0 0,7	45	12	Violet
3/8 Inside Cutting 280 Micron	 	GS1508	6/0 0,7	45	12	Violet
12 mm						
3/8 Reverse Cutting 330 Micron	 	GS1541	6/0 0,7	45	12	Violet
3/8 Spatula 280 Micron	 	GS1523	6/0 0,7	45	12	Violet
13 mm						
1/2 Round Body, Taper Point 330 Micron	 	GS1560	6/0 0,7	45	12	Violet
		GS1564	6/0 0,7	75	12	Violet

Glikosorb

Surgical Suture, Polyglycolicacid (PGA) Absorbable, Synthetic, Braided

Needle Length and description	Product No	USP EP	Length (cm)	Unit Pcs	Color	
13 mm						
1/2 Round Body, Taper Point 330 Micron	 	GS1561	6/0 0,7	45	12	Violet
1/2 Round Body, Taper Point 380 Micron	 	GS1885	5/0 1,0	75	12	Violet
1/2 Round Body, Taper Point 430 Micron	 	GS1894	5/0 1,0	75	12	Violet
3/8 Round Body, Taper Point 330 Micron	 	GS1580	6/0 0,7	45	12	Violet
		GS1590	6/0 0,7	75	12	Violet
3/8 Round Body, Taper Point 380 Micron	 	GS1914	5/0 1,0	75	12	Violet
3/8 Round Body, Taper Point 430 Micron	 	GS2432	4/0 1,5	45	12	Violet
		GS2434	4/0 1,5	60	12	Violet
3/8 Reverse Cutting 380 Micron	 	GS1928	5/0 1,0	75	12	Violet
3/8 Reverse Cutting 560 Micron	 	GS2456	4/0 1,5	75	12	Violet
3/8 Spatula 280 Micron	 	GS1605	6/0 0,7	45	12	Violet
3/8 Spatula 330 Micron	 	GS1873	5/0 1,0	60	12	Violet
3/8 Trocar 330 Micron	 	GS2416	4/0 1,5	45	12	Violet
16 mm						
1/2 Round Body, Taper Point	 	GS1990	5/0 1,0	75	12	Violet
		GS1992	5/0 1,0	75	12	Undyed
		GS2503	4/0 1,5	75	12	Undyed
		GS2504	4/0 1,5	75	12	Violet





Glikosorb

Surgical Suture, Polyglycolicacid (PGA) Absorbable, Synthetic, Braided

Needle Length and description			Product No	USP EP	Length (cm)	Unit Pcs	Color
16 mm							
1/2 Round Body, Taper Point			GS3005	3/0 2,0	75	12	Violet
			GS1674	6/0 0,7	75	12	Violet
3/8 Reverse Cutting			GS2014	5/0 1,0	45	12	Undyed
			GS2540	4/0 1,5	75	12	Violet
			GS3025	3/0 2,0	75	12	Violet
			GS2140	5/0 1,0	45	12	Violet
3/8 Inside Cutting			GS2144	5/0 1,0	75	12	Violet
			GS2557	4/0 1,5	75	12	Undyed
			GS3039	3/0 2,0	75	12	Violet
			GS2140	5/0 1,0	45	12	Violet
17 mm							
1/2 Round Body, Taper Point			GS2584	4/0 1,5	75	12	Violet
18 mm							
1/2 Round Body, Taper Point			GS5525	5/0 1,0	75	12	Violet
			GS2613	4/0 1,5	75	12	Violet
			GS3624	2/0 3,0	75	12	Violet
3/8 Round Body, Taper Point			GS3085	3/0 2,0	75	12	Violet
19 mm							
3/8 Reverse Cutting			GS1706	6/0 0,7	75	12	Violet
			GS2640	4/0 1,5	75	12	Violet
3/8 Reverse Cutting Premium			GS2211	5/0 1,0	45	12	Violet



Glikosorb









Surgical Suture, Polyglycolicacid (PGA) Absorbable, Synthetic, Braided



Needle Length and description	Product No	USP EP	Length (cm)	Unit Pcs	Color
20 mm					
1/2 Round Body, Taper Point 	GS2229	5/0 1,0	75	12	Violet
	GS2685	4/0 1,5	75	12	Violet
	GS3142	3/0 2,0	75	12	Violet
1/2 Tapercutting 	GS2673	4/0 1,5	75	12	Violet
3/8 Reverse Cutting 	GS2250	5/0 1,0	75	12	Undyed
	GS2716	4/0 1,5	45	12	Undyed
	GS2719	4/0 1,5	75	12	Violet
	GS3164	3/0 2,0	45	12	Violet
	GS3168	3/0 2,0	75	12	Violet
	GS3663	2/0 3,0	75	12	Violet
22 mm					
1/2 Round Body, Taper Point 	GS2747	4/0 1,5	75	12	Violet
	GS3196	3/0 2,0	75	12	Violet
	GS3671	2/0 3,0	75	12	Violet
	GS4575	1 4,0	75	12	Violet
3/8 Reverse Cutting 	GS2763	4/0 1,5	75	12	Violet
	GS3214	3/0 2,0	90	12	Violet

Glikosorb

Surgical Suture, Polyglycolicacid (PGA) Absorbable, Synthetic, Braided







Needle Length and description	Product No	USP EP	Length (cm)	Unit Pcs	Color
24 mm					
1/2 Reverse Cutting  	GS5524	4/0 1,5	75	12	Violet
	GS5523	3/0 2,0	75	12	Violet
	GS3692	2/0 3,0	75	12	Violet

25 mm					
1/2 Round Body, Taper Point  	GS2788	4/0 1,5	75	12	Violet
	GS3252	3/0 2,0	75	12	Violet
	GS3746	2/0 3,0	100	12	Violet
	GS3724	2/0 3,0	75	12	Violet
1/2 Tapercutting  	GS3718	2/0 3,0	75	12	Violet
3/8 Reverse Cutting  	GS2804	4/0 1,5	75	12	Violet
	GS3757	2/0 3,0	75	12	Violet
3/8 Inside Cutting  	GS2812	4/0 1,5	45	12	Violet
	GS3284	3/0 2,0	45	12	Violet
	GS3763	2/0 3,0	75	12	Violet

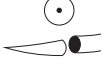
26 mm					
1/2 Round Body, Taper Point  	GS2292	5/0 1,0	75	12	Violet
	GS2828	4/0 1,5	75	12	Violet
	GS3313	3/0 2,0	75	12	Violet
	GS3318	3/0 2,0	90	12	Violet
	GS3786	2/0 3,0	75	12	Violet





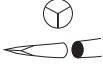

Glikosorb

Surgical Suture, Polyglycolicacid (PGA) Absorbable, Synthetic, Braided

Needle Length and description	Product No	USP EP	Length (cm)	Unit Pcs	Color
26 mm					
1/2 Round Body, Taper Point  	GS4215	0 3,5	75	12	Violet
	GS4592	1 4,0	90	12	Violet
1/2 Reverse Cutting  	GS4230	0 3,5	75	12	Violet
3/8 Round Body, Taper Point  	GS2841	4/0 1,5	75	12	Violet
3/8 Reverse Cutting  	GS3345	3/0 2,0	75	12	Undyed
	GS3346	3/0 2,0	75	12	Violet
	GS3821	2/0 3,0	75	12	Undyed
	GS3822	2/0 3,0	75	12	Violet
30 mm					
1/2 Round Body, Taper Point  	GS3369	3/0 2,0	75	12	Violet
	GS3374	3/0 2,0	90	12	Violet
	GS3858	2/0 3,0	75	12	Violet
	GS4244	0 3,5	75	12	Violet
	GS4608	1 4,0	75	12	Violet
1/2 Reverse Cutting  	GS3882	2/0 3,0	75	12	Violet
	GS4266	0 3,5	75	12	Violet
1/2 Tapercutting  	GS3843	2/0 3,0	75	12	Violet



Glikosorb

Surgical Suture, Polyglycolicacid (PGA) Absorbable, Synthetic, Braided

Needle Length and description	Product No	USP EP	Length (cm)	Unit Pcs	Color
30 mm					
3/8 Reverse Cutting 	GS2887	4/0 1,5	75	12	Violet
	GS3397	3/0 2,0	75	12	Violet
	GS3891	2/0 3,0	75	12	Violet
	GS4273	0 3,5	75	12	Violet
32 mm					
1/2 Round Body, Taper Point 	GS5508	3/0 2,0	75	12	Violet
35 mm					
1/2 Round Body, Taper Point 	GS3411	3/0 2,0	75	12	Violet
	GS3916	2/0 3,0	75	12	Violet
	GS3922	2/0 3,0	90	12	Violet
	GS4300	0 3,5	75	12	Violet
	GS4644	1 4,0	75	12	Violet
3/8 Reverse Cutting 	GS3423	3/0 2,0	75	12	Violet
	GS3933	2/0 3,0	75	12	Violet
36 mm					
1/2 Round Body, Taper Point 	GS5509	3/0 2,0	75	12	Violet
1/2 Reverse Cutting 	GS4675	1 4,0	75	12	Violet



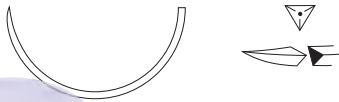
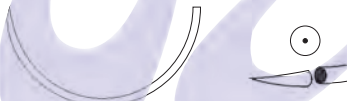







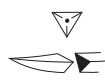

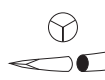
Glikosorb

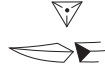
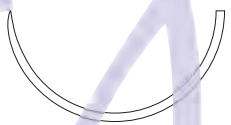
Surgical Suture, Polyglycolicacid (PGA) Absorbable, Synthetic, Braided

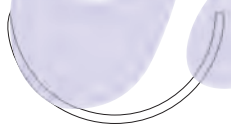
Needle Length and description	Product No	USP EP	Length (cm)	Unit Pcs	Color
37 mm					
1/2 Round Body, Taper Point 	GS3950	2/0 3,0	75	12	Violet
	GS4337	0 3,5	75	12	Violet
	GS4681	1 4,0	75	12	Violet
1/2 Reverse Cutting 	GS5507	2/0 3,0	75	12	Violet
	GS4354	0 3,5	90	12	Violet
	GS4994	2 5,0	75	12	Violet
40 mm					
1/2 Round Body, Taper Point 	GS3982	2/0 3,0	75	12 [®]	Violet
	GS4368	0 3,5	75	12	Violet
	GS4375	0 3,5	90	12	Violet
	GS4713	1 4,0	75	12	Violet
	GS4719	1 4,0	90	12	Violet
	GS5003	2 5,0	75	12	Violet
	GS5006	2 5,0	90	12	Violet
1/2 Reverse Cutting 	GS4397	0 3,5	75	12	Violet
	GS4745	1 4,0	75	12	Violet
	GS4749	1 4,0	90	12	Violet
	GS5019	2 5,0	75	12	Violet

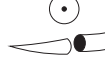

Glikosorb

Surgical Suture, Polyglycolicacid (PGA) Absorbable, Synthetic, Braided

Needle Length and description	Product No	USP EP	Length (cm)	Unit Pcs	Color	
40 mm						
1/2 Reverse Cutting	 	GS5023	2 5,0	90	12	Violet
1/2 Tapercutting	 	GS4363	0 3,5	75	12	Violet
3/8 Reverse Cutting	 	GS4756	1 4,0	75	12	Violet
		GS4408	0 3,5	75	12	Violet
45 mm						
1/2 Round Body, Taper Point	 	GS4422	0 3,5	75	12	Violet
		GS4772	1 4,0	75	12	Violet
		GS5035	2 5,0	75	12	Violet
		GS5040	2 5,0	90	12	Violet
1/2 Tapercutting	 	GS4766	1 4,0	75	12	Violet
		GS5738	2 5,0	75	12	Violet
3/8 Reverse Cutting	 	GS4432	0 3,5	75	12	Violet
		GS4787	1 4,0	75	12	Violet
Straight Reverse Cutting	 	GS2909	4/0 1,5	45	12	Violet
48 mm						
1/2 Round Body, Taper Point	 	GS4796	1 4,0	75	12	Violet

Glikosorb

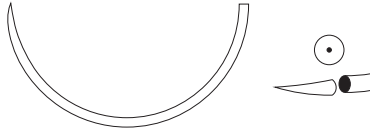
Surgical Suture, Polyglycolicacid (PGA) Absorbable, Synthetic, Braided

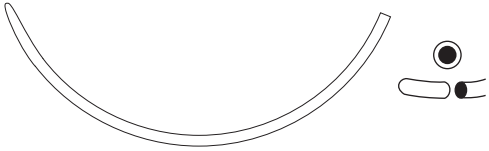
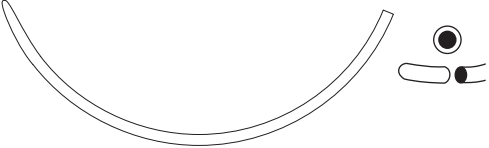
Needle Length and description	Product No	USP EP	Length (cm)	Unit Pcs	Color
50 mm					
1/2 Round Body, Taper Point 	GS4454	0 3,5	75	12	Violet
	GS4459	0 3,5	90	12	Violet
	GS4812	1 4,0	75	12	Violet
	GS4818	1 4,0	90	12	Violet
	GS5066	2 5,0	75	12	Violet
	GS5070	2 5,0	90	12	Violet
1/2 Reverse Cutting 	GS4471	0 3,5	75	12	Violet
60 mm					
Straight Reverse Cutting 	GS3492	3/0 2,0	75	12	Violet
	GS4074	2/0 3,0	75	12	Violet
63 mm					
3/8 Blunt 	GS4858	1 4,0	75	12	Violet
64 mm					
3/8 Blunt 	GS4500	0 3,5	90	12	Violet
	GS4861	1 4,0	90	12	Violet

Glikosorb

Surgical Suture, Polyglycolicacid (PGA) Absorbable, Synthetic, Braided

Non-Needle Suture	Product No	USP EP	Length (cm)	Unit Pcs	Color
6x45 cm					
GLIKOSORB Non-Needle Suture	GS2950	3/0 2,0	6x45	12	Violet
	GS3543	2/0 3,0	6x45	12	Violet
	GS4137	0 3,5	6x45	12	Violet
	GS4563	1 4,0	6x45	12	Violet
10x50 cm					
GLIKOSORB Non-Needle Suture	GS2954	3/0 2,0	10x50	12	Violet
	GS3548	2/0 3,0	10x75	12	Violet
12x45 cm					
GLIKOSORB Non-Needle Suture	GS2344	4/0 1,5	12x45	12	Violet
	GS2958	3/0 2,0	12x45	12	Violet
	GS3552	2/0 3,0	12x45	12	Violet
	GS4145	0 3,5	12x45	12	Violet
	GS4554	1 4,0	12x45	12	Violet
17x45 cm					
GLIKOSORB Non-Needle Suture	GS2966	3/0 2,0	17x45	12	Violet
	GS3558	2/0 3,0	17x45	12	Violet
150 cm					
GLIKOSORB Non-Needle Suture	GS1737	5/0 1,0	150	12	Violet
	GS2326	4/0 1,5	150	12	Violet
	GS2935	3/0 2,0	150	12	Violet

Glikosorb

Surgical Suture, Polyglycolicacid (PGA) Absorbable, Synthetic, Braided

Non-Needle Suture	Product No	USP EP	Length (cm)	Unit Pcs	Color
150 cm					
GLIKOSORB Non-Needle Suture	GS3511	2/0 3,0	150	12	Violet
	GS4114	0 3,5	150	12	Violet
	GS4532	1 4,0	150	12	Violet

250 cm					
GLIKOSORB Non-Needle Suture	GS2332	4/0 1,5	250	12	Violet
	GS2942	3/0 2,0	250	12	Violet
	GS3518	2/0 3,0	250	12	Violet
	GS4121	0 3,5	250	12	Violet
	GS4541	1 4,0	250	12	Violet

Glikolak

Surgical Sutures
Absorbable

Surgical Suture, Poly[glycolide(90%)-co-lactide(10%)](PGLA)
Absorbable, Synthetic, Braided

Boz[®]



Definition

Synthetic absorbable, coated, mid term wound support and mid term mass absorption.

Material

Poly(glycolide-co-lactide)
glycolide 90% -lactide 10 % (PGLA)

Coating

Poly(glycolide-co-lactide) (30/70) & calcium stearate

Structure

Braided-Multifilament

Colour

Beige (undyed) or Violet (dyed)

Size

EP : 0.4 to 5

USP : 8/0 to 2

Tensile Strength Retention

2. Week 75%

Mass Absorption

55-70 days

Sterilization Method

Ethylene Oxide Gas

Main Indication

Gastrointestinal Surgery

Gynaecology

Ophthalmic Surgery

Orthopedics



















Urology

Skin closer - intracutaneous, subcutaneous.

Ligatures

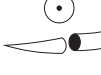
Glikolak

Surgical Suture, Poly[glycolide(90%)-co-lactide(10%)](PGLA)
Absorbable, Synthetic, Braided

Needle Length and description	Product No	USP EP	Length (cm)	Unit Pcs	Color	
6 mm						
3/8 Reverse Cutting 150 Micron	 	GL1165	8/0 0,4	45	12	Violet
3/8 Reverse Cutting 150 Micron	 	GL1256	7/0 0,5	45	12	Violet
3/8 Spatula 230 Micron	 	GL1155	8/0 0,4	30	12	Violet
3/8 Spatula 230 Micron	 	GL1253	7/0 0,5	45	12	Violet
8 mm						
1/2 Spatula 330 Micron	 	GL1394	6/0 0,7	30	12	Violet
1/4 Spatula 340 Micron	 	GL1405	6/0 0,7	45	12	Violet
1/4 Spatula 340 Micron	 	GL1404	6/0 0,7	30	12	Violet
		GL1764	5/0 1,0	45	12	Violet
3/8 Round Body, Taper Point 280 Micron	 	GL1299	7/0 0,5	45	12	Violet
3/8 Round Body, Taper Point 280 Micron	 	GL1432	6/0 0,7	75	12	Violet
3/8 Spatula 230 Micron	 	GL5827	8/0 0,4	45	12	Violet
3/8 Spatula 280 Micron	 	GL1413	6/0 0,7	45	12	Violet
10 mm						
3/8 Round Body, Taper Point 340 Micron	 	GL1803	5/0 1,0	45	12	Violet
3/8 Reverse Cutting 330 Micron	 	GL1496	6/0 0,7	45	12	Violet
3/8 Spatula 280 Micron	 	GL1450	6/0 0,7	45	12	Violet
3/8 Spatula 330 Micron	 	GL1790	5/0 1,0	75	12	Violet









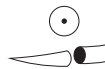

Glikolak

Surgical Suture, Poly[glycolide(90%)-co-lactide(10%)](PGLA)
Absorbable, Synthetic, Braided

Needle Length and description	Product No	USP EP	Length (cm)	Unit Pcs	Color
12 mm					
1/2 Round Body, Taper Point 430 Micron	GL1836	5/0 1,0	45	12	Violet
13 mm					
1/2 Round Body, Taper Point 330 Micron	GL1560	6/0 0,7	45	12	Violet
	GL1564	6/0 0,7	75	12	Violet
1/2 Round Body, Taper Point 430 Micron	GL1894	5/0 1,0	75	12	Violet
	GL1900	5/0 1,0	90	12	Violet
3/8 Round Body, Taper Point 330 Micron	GL1580	6/0 0,7	45	12	Violet
3/8 Round Body, Taper Point 380 Micron	GL1914	5/0 1,0	75	12	Violet
3/8 Round Body, Taper Point 430 Micron	GL2434	4/0 1,5	60	12	Violet
3/8 Reverse Cutting Premium 330 Micron	GL1626	6/0 0,7	45	12	Violet
16 mm					
1/2 Round Body, Taper Point	GL1990	5/0 1,0	75	12	Violet
	GL1994	5/0 1,0	75	12	Violet
1/2 Round Body, Taper Point	GL2504	4/0 1,5	75	12	Violet
	GL3005	3/0 2,0	75	12	Violet
3/8 Reverse Cutting	GL2021	5/0 1,0	75	12	Violet
	GL2540	4/0 1,5	75	12	Violet
	GL3025	3/0 2,0	75	12	Violet
3/8 Inside Cutting	GL2144	5/0 1,0	75	12	Violet

Glikolak



Surgical Suture, Poly[glycolide(90%)-co-lactide(10%)](PGLA)
Absorbable, Synthetic, Braided



Needle Length and description	Product No	USP EP	Length (cm)	Unit Pcs	Color
16 mm					
3/8 Inside Cutting  	GL2557	4/0 1,5	75	12	Undyed
	GL2553	4/0 1,5	45	12	Violet
	GL3039	3/0 2,0	75	12	Violet
17 mm					
1/2 Round Body, Taper Point  	GL2165	5/0 1,0	75	12	Violet
18 mm					
1/2 Round Body, Taper Point  	GL2613	4/0 1,5	75	12	Violet
19 mm					
3/8 Reverse Cutting  	GL1706	6/0 0,7	75	12	Violet
	GL2206	5/0 1,0	75	12	Violet
	GL2640	4/0 1,5	75	12	Violet
	GL3109	3/0 2,0	75	12	Violet
20 mm					
1/2 Round Body, Taper Point  	GL2229	5/0 1,0	75	12	Violet
	GL2685	4/0 1,5	75	12	Violet
	GL2690	4/0 1,5	90	12	Violet
	GL3142	3/0 2,0	75	12	Violet
3/8 Reverse Cutting  	GL2716	4/0 1,5	45	12	Undyed
	GL3164	3/0 2,0	45	12	Violet
	GL3663	2/0 3,0	75	12	Violet

Glikolak

Surgical Suture, Poly[glycolide(90%)-co-lactide(10%)](PGLA)
Absorbable, Synthetic, Braided

Needle Length and description	Product No	USP EP	Length (cm)	Unit Pcs	Color
25 mm					
1/2 Round Body, Taper Point 	GL2788	4/0 1,5	75	12	Violet
	GL3252	3/0 2,0	75	12	Violet
	GL3746	2/0 3,0	100	12	Violet
	GL3724	2/0 3,0	75	12	Violet





25 mm						
3/8 Reverse Cutting 	GL2804	4/0 1,5	75	12	Violet	
	3/8 Inside Cutting 	GL2812	4/0 1,5	45	12	Violet
		GL3284	3/0 2,0	45	12	Violet
	GL3763	2/0 3,0	75	12	Violet	

26 mm					
1/2 Round Body, Taper Point 	GL3313	3/0 2,0	75	12	Violet
	GL4220	0 3,5	90	12	Violet
3/8 Reverse Cutting 	GL2852	4/0 1,5	75	12	Violet
	GL3346	3/0 2,0	75	12	Violet
	GL3822	2/0 3,0	75	12	Violet

30 mm					
1/2 Round Body, Taper Point 	GL3369	3/0 2,0	75	12	Violet
	GL3858	2/0 3,0	75	12	Violet
	GL3865	2/0 3,0	90	12	Violet

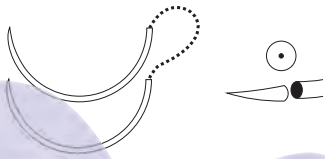





Glikolak

Surgical Suture, Poly[glycolide(90%)-co-lactide(10%)](PGLA)
Absorbable, Synthetic, Braided

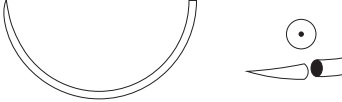
Needle Length and description	Product No	USP EP	Length (cm)	Unit Pcs	Color
30 mm					
1/2 Round Body, Taper Point 	GL4244	0 3,5	75	12	Violet
	GL4250	0 3,5	90	12	Violet
	GL4608	1 4,0	75	12	Violet
	GL4614	1 4,0	90	12	Violet
1/2 Round Body, Taper Point 	GL3854	2/0 3,0	75	12	Violet
3/8 Reverse Cutting 	GL3397	3/0 2,0	75	12	Violet
	GL3891	2/0 3,0	75	12	Violet
	GL3895	2/0 3,0	90	12	Violet
	GL4273	0 3,5	75	12	Violet
35 mm					
1/2 Round Body, Taper Point 	GL3916	2/0 3,0	75	12	Violet
	GL4300	0 3,5	75	12	Violet
	GL4644	1 4,0	75	12	Violet
	GL4649	1 4,0	90	12	Violet
3/8 Reverse Cutting 	GL3423	3/0 2,0	75	12	Violet
	GL3933	2/0 3,0	75	12	Violet
	GL5881	1 4,0	75	12	Violet

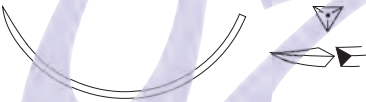

Glikolak

Surgical Suture, Poly[glycolide(90%)-co-lactide(10%)](PGLA)
Absorbable, Synthetic, Braided

Needle Length and description	Product No	USP EP	Length (cm)	Unit Pcs	Color
40 mm					
1/2 Round Body, Taper Point 	GL3982	2/0 3,0	75	12	Violet
	GL4368	0 3,5	75	12	Violet
	GL4375	0 3,5	90	12	Violet
	GL4713	1 4,0	75	12	Violet
	GL4719	1 4,0	90	12	Violet
	GL5003	2 5,0	75	12	Violet
1/2 Reverse Cutting 	GL4399	0 3,5	90	12	Violet
	GL4749	1 4,0	90	12	Violet
	GL5019	2 5,0	75	12	Violet
3/8 Reverse Cutting 	GL4408	0 3,5	75	12	Violet
45 mm					
1/2 Round Body, Taper Point 	GL4772	1 4,0	75	12	Violet
	GL4775	1 4,0	90	12	Violet
	GL5035	2 5,0	75	12	Violet
3/8 Reverse Cutting 	GL4022	2/0 3,0	75	12	Violet
	GL4432	0 3,5	75	12	Violet
	GL4787	1 4,0	75	12	Violet
Straight Reverse Cutting 	GL2909	4/0 1,5	45	12	Violet

Glikolak

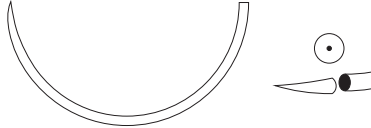
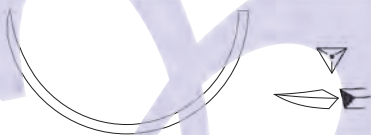
Surgical Suture, Poly[glycolide(90%)-co-lactide(10%)](PGLA)
Absorbable, Synthetic, Braided

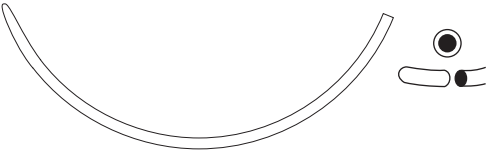
Needle Length and description	Product No	USP EP	Length (cm)	Unit Pcs	Color
50 mm					
1/2 Round Body, Taper Point 	GL4454	0 3,5	75	12	Violet
	GL4459	0 3,5	90	12	Violet
	GL4812	1 4,0	75	12	Violet
	GL4818	1 4,0	90	12	Violet
	GL5066	2 5,0	75	12	Violet
	GL5070	2 5,0	90	12	Violet
1/2 Reverse Cutting 	GL5078	2 5,0	75	12	Violet
60 mm					
Straight Reverse Cutting 	GL2923	4/0 1,5	75	12	Violet
	GL3492	3/0 2,0	75	12	Violet
	GL4074	2/0 3,0	75	12	Violet
63 mm					
3/8 Blunt 	GL4858	1 4,0	75	12	Violet
64 mm					
3/8 Blunt 	GL4861	1 4,0	90	12	Violet

Glikolak

Surgical Suture, Poly[glycolide(90%)-co-lactide(10%)](PGLA)
Absorbable, Synthetic, Braided

Non-Needle Suture	Product No	USP EP	Length (cm)	Unit Pcs	Color
6x45 cm					
GLIKOLAK Non-Needle Suture	GL2950	3/0 2,0	6x45	12	Violet
	GL4137	0 3,5	6x45	12	Violet
	GL4563	1 4,0	6x45	12	Violet

12x45 cm					
GLIKOLAK Non-Needle Suture	GL2344	4/0 1,5	12x45	12	Violet
	GL2958	3/0 2,0	12x45	12	Violet
	GL3552	2/0 3,0	12x45	12	Violet
	GL4145	0 3,5	12x45	12	Violet
	GL4554	1 4,0	12x45	12	Violet

17x45 cm					
GLIKOLAK Non-Needle Suture	GL2966	3/0 2,0	17x45	12	Violet
	GL4559	1 4,0	17x45	12	Violet

10x50 cm					
GLIKOLAK Non-Needle Suture	GL4140	0 3,5	10x50	12	Violet
	GL2955	3/0 2,0	10x75	12	Violet

10x75 cm					
GLIKOLAK Non-Needle Suture	GL4550	1 4,0	10x75	12	Violet

Glikolak

Surgical Suture, Poly[glycolide(90%)-co-lactide(10%)](PGLA)
Absorbable, Synthetic, Braided

Non-Needle Suture	Product No	USP EP	Length (cm)	Unit Pcs	Color
150 cm					
GLIKOLAK Non-Needle Suture	GL1737	5/0 1,0	150	12	Violet
	GL2326	4/0 1,5	150	12	Violet
	GL2935	3/0 2,0	150	12	Violet
	GL3511	2/0 3,0	150	12	Violet
	GL4114	0 3,5	150	12	Violet
	GL4532	1 4,0	150	12	Violet

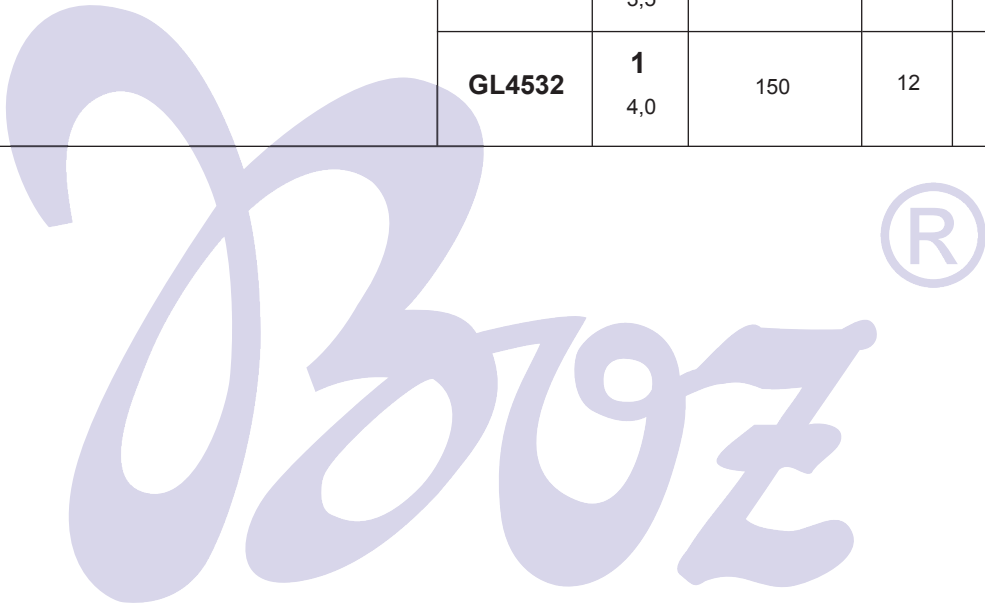

Fastorb

Surgical Suture, Polyglycolicacid (PGA)
Fast Absorbable, Synthetic, Braided, Undyed

Surgical Sutures
Absorbable



BOZ[®]

Definition

Synthetic absorbable, coated, short term wound support and short term mass absorption.

Material

Polyglycolic Acid (PGA)

Coating

Calcium Stearate and polycaprolactone

Structure

Braided

Colour

Beige (undyed)

Size

EP : 0.4 to 8

USP : 8/0 to 6

Tensile Strength Retention

7 Days 75 %

Mass Absorption

42 days

Sterilization Method

Gamma Irradiation

Main Indication

Gynaecology (episiotomies)

Urology

Ophthalmic surgery (conjunctive suturing)

Odontology (oral mucosa)

Pediatric surgery

Skin closer - intracutaneous, subcutaneous.

Ligatures







Fastorb

Surgical Suture, Polyglycolicacid (PGA) Fast Absorbable, Synthetic, Braided, Undyed

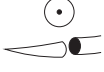
Needle Length and description	Product No	USP EP	Length (cm)	Unit Pcs	Color
12 mm					
3/8 Reverse Cutting 330 Micron	FS1545	6/0 0,7	75	12	Undyed
13 mm					
1/2 Round Body, Taper Point 330 Micron	FS1563	6/0 0,7	75	12	Undyed
1/2 Round Body, Taper Point 380 Micron	FS1886	5/0 1,0	75	12	Undyed
3/8 Reverse Cutting 330 Micron	FS5912	6/0 0,7	75	12	Undyed
3/8 Reverse Cutting 380 Micron	FS1929	5/0 1,0	75	12	Undyed
3/8 Reverse Cutting Premium 380 Micron	FS1941	5/0 1,0	45	12	Undyed
16 mm					
1/2 Round Body, Taper Point	FS1989	5/0 1,0	75	12	Undyed
	FS2503	4/0 1,5	75	12	Undyed
3/8 Reverse Cutting	FS1673	6/0 0,7	75	12	Undyed
	FS2019	5/0 1,0	75	12	Undyed
	FS2539	4/0 1,5	75	12	Undyed
3/8 Inside Cutting	FS2557	4/0 1,5	75	12	Undyed
	FS3038	3/0 2,0	75	12	Undyed
19 mm					
3/8 Reverse Cutting	FS2639	4/0 1,5	75	12	Undyed
	FS3108	3/0 2,0	75	12	Undyed
20 mm					
1/2 Round Body, Taper Point	FS2228	5/0 1,0	75	12	Undyed

Fastorb

Surgical Suture, Polyglycolicacid (PGA) Fast Absorbable, Synthetic, Braided, Undyed

Needle Length and description			Product No	USP EP	Length (cm)	Unit Pcs	Color
20 mm							
1/2 Round Body, Taper Point			FS2683	4/0 1,5	75	12	Undyed
			FS3141	3/0 2,0	75	12	Undyed
3/8 Reverse Cutting			FS2250	5/0 1,0	75	12	Undyed
22 mm							
1/2 Round Body, Taper Point			FS2745	4/0 1,5	75	12	Undyed
25 mm							
1/2 Round Body, Taper Point			FS2787	4/0 1,5	75	12	Undyed
			FS3251	3/0 2,0	75	12	Undyed
3/8 Reverse Cutting			FS3273	3/0 2,0	75	12	Undyed
			FS3756	2/0 3,0	75	12	Undyed
26 mm							
1/2 Round Body, Taper Point			FS3785	2/0 3,0	75	12	Undyed
			FS4214	0 3,5	75	12	Undyed
3/8 Reverse Cutting			FS3821	2/0 3,0	75	12	Undyed
			FS4236	0 3,5	75	12	Undyed
			FS3345	3/0 2,0	75	12	Undyed
30 mm							
1/2 Round Body, Taper Point			FS3368	3/0 2,0	75	12	Undyed
			FS3857	2/0 3,0	75	12	Undyed
			FS4243	0 3,5	75	12	Undyed
			FS4607	1 4,0	75	12	Undyed

Fastorb

Surgical Suture, Polyglycolicacid (PGA) Fast Absorbable, Synthetic, Braided, Undyed

Needle Length and description	Product No	USP EP	Length (cm)	Unit Pcs	Color
30 mm					
3/8 Reverse Cutting 	FS2885	4/0 1,5	75	12	Undyed
	FS3396	3/0 2,0	75	12	Undyed
	FS4628	1 4,0	75	12	Undyed
35 mm					
1/2 Round Body, Taper Point 	FS3915	2/0 3,0	75	12	Undyed
	FS4299	0 3,5	75	12	Undyed
	FS4305	0 3,5	90	12	Undyed
	FS4643	1 4,0	75	12	Undyed
	FS4648	1 4,0	90	12	Undyed
3/8 Reverse Cutting 	FS3422	3/0 2,0	75	12	Undyed
	FS3932	2/0 3,0	75	12	Undyed
37 mm					
1/2 Round Body, Taper Point 	FS3954	2/0 3,0	90	12	Undyed
40 mm					
1/2 Round Body, Taper Point 	FS3981	2/0 3,0	75	12	Undyed
	FS3988	2/0 3,0	90	12	Undyed
	FS4367	0 3,5	75	12	Undyed
	FS4374	0 3,5	90	12	Undyed

Fastorb

Surgical Suture, Polyglycolicacid (PGA) Fast Absorbable, Synthetic, Braided, Undyed

Needle Length and description	Product No	USP EP	Length (cm)	Unit Pcs	Color
40 mm					
1/2 Round Body, Taper Point 	FS4712	1 4,0	75	12	Undyed
	FS4718	1 4,0	90	12	Undyed
	FS5001	2 5,0	75	12	Undyed
3/8 Reverse Cutting 	FS4005	2/0 3,0	75	12	Undyed
45 mm					
1/2 Round Body, Taper Point 	FS4421	0 3,5	75	12	Undyed
	FS4771	1 4,0	75	12	Undyed
	FS5034	2 5,0	75	12	Undyed
Straight Reverse Cutting 	FS2911	4/0 1,5	75	12	Undyed
50 mm					
1/2 Round Body, Taper Point 	FS4037	2/0 3,0	75	12	Undyed
	FS4453	0 3,5	75	12	Undyed
	FS4811	1 4,0	75	12	Undyed
	FS5065	2 5,0	75	12	Undyed
65 mm					
1/2 Round Body, Taper Point 	FS4864	1 4,0	100	12	Undyed

Fastorb

Surgical Suture, Polyglycolicacid (PGA) Fast Absorbable, Synthetic, Braided, Undyed

Non-Needle Suture	Product No	USP EP	Length (cm)	Unit Pcs	Color
150 cm					
<p>FASTSORB Non-Needle Suture</p>	FS1373	6/0 0,7	150	12	Undyed
	FS2325	4/0 1,5	150	12	Undyed
	FS2934	3/0 2,0	150	12	Undyed
	FS3510	2/0 3,0	150	12	Undyed
	FS4113	0 3,5	150	12	Undyed
	FS4531	1 4,0	150	12	Undyed
	FS4907	2 5,0	150	12	Undyed

Fastlak

Surgical Suture, Poly[glycolide(90%)-co-lactide(10%)](PGLA)
Fast Absorbable, Synthetic, Braided, Undyed

Surgical Sutures
Absorbable

BOZ[®]



Definition

Synthetic absorbable, coated, short term wound support and short term mass absorption.

Material

Poly(glycolide-co-lactide)
glycolide 90% -lactide 10 % (PGLA)

Coating

Poly(glycolide-co-lactide) (30/70) & calcium stearate

Structure

Braided

Colour

Beige (undyed)

Size

EP : 0.4 to 5

USP : 8/0 to 2

Tensile Strength Retention

7 Days 50 % - 10-14 Days 0 %

Mass Absorption

42 days

Sterilization Method

Gamma Irradiation

Main Indication

Gynaecology (episiotomies)

Urology

Ophthalmic surgery (conjunctive suturing)

Odontology (oral mucosa)

Pediatric surgery

Skin closer - intracutaneous, subcutaneous.

Ligatures

Fastlak

Surgical Suture, Poly[glycolide(90%)-co-lactide(10%)](PGLA)
Fast Absorbable, Synthetic, Braided, Undyed

Needle Length and description	Product No	USP EP	Length (cm)	Unit Pcs	Color
12 mm					
3/8 Reverse Cutting 330 Micron	FL1545	6/0 0,7	75	12	Undyed
13 mm					
1/2 Round Body, Taper Point 380 Micron	FL1886	5/0 1,0	75	12	Undyed
3/8 Reverse Cutting 380 Micron	FL1926	5/0 1,0	45	12	Undyed
16 mm					
1/2 Round Body, Taper Point	FL1989	5/0 1,0	75	12	Undyed
	FL2503	4/0 1,5	75	12	Undyed
3/8 Reverse Cutting	FL1673	6/0 0,7	75	12	Undyed
	FL2019	5/0 1,0	75	12	Undyed
	FL2539	4/0 1,5	75	12	Undyed
	FL3024	3/0 2,0	75	12	Undyed
3/8 Inside Cutting	FL2557	4/0 1,5	75	12	Undyed
	FL3038	3/0 2,0	75	12	Undyed
17 mm					
1/2 Round Body, Taper Point	FL1687	6/0 0,7	75	12	Undyed
18 mm					
1/2 Round Body, Taper Point	FL3080	3/0 2,0	75	12	Undyed
19 mm					
3/8 Reverse Cutting	FL2639	4/0 1,5	75	12	Undyed
	FL3108	3/0 2,0	75	12	Undyed





Fastlak

Surgical Suture, Poly[glycolide(90%)-co-lactide(10%)](PGLA)
Fast Absorbable, Synthetic, Braided, Undyed

Needle Length and description		Product No	USP EP	Length (cm)	Unit Pcs	Color	
20 mm							
1/2 Round Body, Taper Point			FL2228	5/0 1,0	75	12	Undyed
			FL2683	4/0 1,5	75	12	Undyed
			FL3141	3/0 2,0	75	12	Undyed
			FL3150	3/0 2,0	90	12	Undyed
3/8 Reverse Cutting			FL2250	5/0 1,0	75	12	Undyed
22 mm							
1/2 Round Body, Taper Point			FL2745	4/0 1,5	75	12	Undyed
			FL3195	3/0 2,0	75	12	Undyed
1/2 Inside Cutting			FL3216	3/0 2,0	45	12	Undyed
3/8 Reverse Cutting			FL3210	3/0 2,0	75	12	Undyed
25 mm							
1/2 Round Body, Taper Point			FL2787	4/0 1,5	75	12	Undyed
			FL3251	3/0 2,0	75	12	Undyed
3/8 Reverse Cutting			FL2805	4/0 1,5	75	12	Undyed
26 mm							
1/2 Round Body, Taper Point			FL3312	3/0 2,0	75	12	Undyed
			FL3785	2/0 3,0	75	12	Undyed
3/8 Reverse Cutting			FL3345	3/0 2,0	75	12	Undyed
			FL3821	2/0 3,0	75	12	Undyed

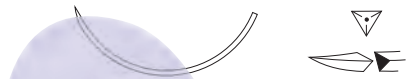

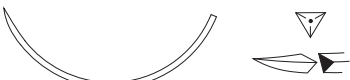
Fastlak

Surgical Suture, Poly[glycolide(90%)-co-lactide(10%)](PGLA)
Fast Absorbable, Synthetic, Braided, Undyed

Needle Length and description		Product No	USP EP	Length (cm)	Unit Pcs	Color
30 mm						
1/2 Round Body, Taper Point 	FL3368	3/0 2,0	75	12	Undyed	
	FL3857	2/0 3,0	75	12	Undyed	
	FL4243	0 3,5	75	12	Undyed	
	FL4607	1 4,0	75	12	Undyed	
3/8 Reverse Cutting 	FL2885	4/0 1,5	75	12	Undyed	
	FL3396	3/0 2,0	75	12	Undyed	
	FL3890	2/0 3,0	75	12	Undyed	
35 mm						
1/2 Round Body, Taper Point 	FL3915	2/0 3,0	75	12	Undyed	
	FL4299	0 3,5	75	12	Undyed	
	FL4305	0 3,5	90	12	Undyed	
	FL4643	1 4,0	75	12	Undyed	
3/8 Reverse Cutting 	FL3422	3/0 2,0	75	12	Undyed	
	FL3932	2/0 3,0	75	12	Undyed	
36 mm						
1/2 Round Body, Taper Point 	FL4667	1 4,0	75	12	Undyed	
40 mm						
1/2 Round Body, Taper Point 	FL3981	2/0 3,0	75	12	Undyed	
	FL3988	2/0 3,0	90	12	Undyed	

Fastlak

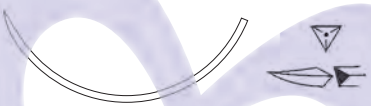
Surgical Suture, Poly[glycolide(90%)-co-lactide(10%)](PGLA)
Fast Absorbable, Synthetic, Braided, Undyed

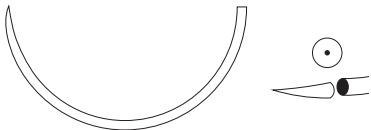
Needle Length and description	Product No	USP EP	Length (cm)	Unit Pcs	Color
40 mm					
1/2 Round Body, Taper Point 	FL4367	0 3,5	75	12	Undyed
	FL4374	0 3,5	90	12	Undyed
	FL4712	1 4,0	75	12	Undyed
	FL4718	1 4,0	90	12	Undyed
	FL5001	2 5,0	75	12	Undyed
3/8 Reverse Cutting 	FL4005	2/0 3,0	75	12	Undyed
	FL4755	1 4,0	75	12	Undyed
45 mm					
1/2 Round Body, Taper Point 	FL4424	0 3,5	90	12	Undyed
	FL4771	1 4,0	75	12	Undyed
	FL5034	2 5,0	75	12	Undyed
Straight Reverse Cutting 	FL2911	4/0 1,5	75	12	Undyed
50 mm					
1/2 Round Body, Taper Point 	FL4037	2/0 3,0	75	12	Undyed
	FL4453	0 3,5	75	12	Undyed
	FL4811	1 4,0	75	12	Undyed
	FL5065	2 5,0	75	12	Undyed

Fastlak

Surgical Suture, Poly[glycolide(90%)-co-lactide(10%)](PGLA)
Fast Absorbable, Synthetic, Braided, Undyed

Non-Needle Suture	Product No	USP EP	Length (cm)	Unit Pcs	Color
150 cm					
<p>FASTLAK Non-Needle Suture</p>	FL1736	5/0 1,0	150	12	Undyed
	FL2325	4/0 1,5	150	12	Undyed
	FL2934	3/0 2,0	150	12	Undyed
	FL3510	2/0 3,0	150	12	Undyed
	FL4113	0 3,5	150	12	Undyed
	FL4531	1 4,0	150	12	Undyed
	FL4907	2 5,0	150	12	Undyed

Surgical Sutures Absorbable

Monokaprol

Surgical Suture, Poly[glycolide(75%)-co-caprolactone(25%)](PGCL)
Absorbable, Synthetic, Monofilament

Boz®

®

Definition

Short-term synthetic absorbable, closure of superficial wounds

Material

Poly(glycolide (75%)- co-caprolactone (25%)) (PGCL)

Coating

No coating

Structure

Monofilament

Colour

Undyed Beige (undyed) or Violet (dyed)

Size

EP : 0.7 to 5
USP : 6/0 to 2

Tensile Strength Retention

1. Week 45 % - 70 %
2. Week 20 %

Mass Absorption

90 - 120 Days

Sterilization Method

Ethylene Oxide Gas

Main Indication

Gynaecology
Obstetrics
Urology
Plastic Surgery
Odontology (oral mucosa)
Skin closer - intracutaneous, subcutaneous.
Reconstructive Surgery
Gastrointestinal Surgery





Monokaprol

Surgical Suture, Poly[glycolide(75%)-co-caprolactone(25%)](PGCL)
Absorbable, Synthetic, Monofilament

Needle Length and description	Product No	USP EP	Length (cm)	Unit Pcs	Color
8 mm					
1/4 Spatula 330 Micron  	MK1398	6/0 0,7	45	12	Undyed
	MK1759	5/0 1,0	45	12	Undyed
10 mm					
3/8 Reverse Cutting 330 Micron  	MK1494	6/0 0,7	45	12	Undyed
13 mm					
3/8 Round Body, Taper Point 330 Micron  	MK1578	6/0 0,7	45	12	Undyed
3/8 Round Body, Taper Point 330 Micron  	MK1905	5/0 1,0	50	12	Undyed
16 mm					
1/2 Round Body, Taper Point  	MK1989	5/0 1,0	75	12	Undyed
	MK2503	4/0 1,5	75	12	Undyed
	MK3004	3/0 2,0	75	12	Undyed
3/8 Reverse Cutting  	MK2539	4/0 1,5	75	12	Undyed
3/8 Inside Cutting  	MK2139	5/0 1,0	45	12	Undyed
	MK2557	4/0 1,5	75	12	Undyed
	MK3038	3/0 2,0	75	12	Undyed
18 mm					
3/8 Reverse Cutting  	MK1704	6/0 0,7	45	12	Undyed
19 mm					
3/8 Reverse Cutting  	MK2639	4/0 1,5	75	12	Undyed
	MK3108	3/0 2,0	75	12	Undyed

Monokaprol

Surgical Suture, Poly[glycolide(75%)-co-caprolactone(25%)](PGCL)
Absorbable, Synthetic, Monofilament

Needle Length and description			Product No	USP EP	Length (cm)	Unit Pcs	Color
20 mm							
1/2 Round Body, Taper Point			MK2683	4/0 1,5	75	12	Undyed
			MK3141	3/0 2,0	75	12	Undyed
3/8 Reverse Cutting			MK2718	4/0 1,5	75	12	Undyed
			MK3167	3/0 2,0	75	12	Undyed
24 mm							
3/8 Inside Cutting			MK3236	3/0 2,0	75	12	Undyed
25 mm							
1/2 Round Body, Taper Point			MK2787	4/0 1,5	75	12	Undyed
			MK3251	3/0 2,0	75	12	Undyed
			MK3252	3/0 2,0	75	12	Violet
			MK3723	2/0 3,0	75	12	Undyed
3/8 Reverse Cutting			MK2805	4/0 1,5	75	12	Undyed
			MK3273	3/0 2,0	75	12	Undyed
3/8 Inside Cutting			MK3762	2/0 3,0	75	12	Undyed
26 mm							
1/2 Round Body, Taper Point			MK3312	3/0 2,0	75	12	Undyed
			MK3313	3/0 2,0	75	12	Violet
			MK3785	2/0 3,0	75	12	Undyed
1/2 Round Body, Taper Point			MK5846	2/0 3,0	75	12	Undyed
1/2 Reverse Cutting			MK3335	3/0 2,0	75	12	Undyed



Monokaprol

Surgical Suture, Poly[glycolide(75%)-co-caprolactone(25%)](PGCL)
Absorbable, Synthetic, Monofilament

Needle Length and description	Product No	USP EP	Length (cm)	Unit Pcs	Color
26 mm					
1/2 Reverse Cutting 	MK4229	0 3,5	75	12	Undyed
	MK2851	4/0 1,5	75	12	Undyed
3/8 Reverse Cutting 	MK3345	3/0 2,0	75	12	Undyed
	MK3821	2/0 3,0	75	12	Undyed
30 mm					
1/2 Round Body, Taper Point 	MK3368	3/0 2,0	75	12	Undyed
	MK3369	3/0 2,0	75	12	Violet
	MK3857	2/0 3,0	75	12	Undyed
	MK3858	2/0 3,0	75	12	Violet
	MK4243	0 3,5	75	12	Undyed
	MK4607	1 4,0	75	12	Undyed
3/8 Round Body, Taper Point 	MK4263	0 3,5	75	12	Undyed
3/8 Reverse Cutting 	MK3890	2/0 3,0	75	12	Undyed
	MK4272	0 3,5	75	12	Undyed
	MK4628	1 4,0	75	12	Undyed
35 mm					
1/2 Round Body, Taper Point 	MK3915	2/0 3,0	75	12	Undyed
	MK4299	0 3,5	75	12	Undyed
	MK4643	1 4,0	75	12	Undyed

Monokaprol

Surgical Suture, Poly[glycolide(75%)-co-caprolactone(25%)](PGCL)
Absorbable, Synthetic, Monofilament

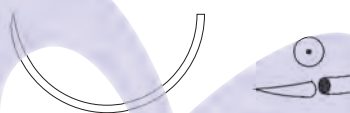
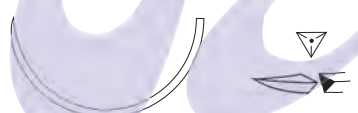
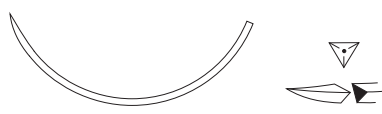
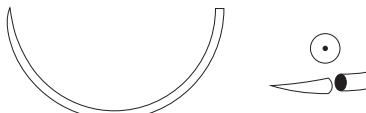
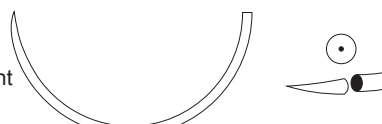
Needle Length and description	Product No	USP EP	Length (cm)	Unit Pcs	Color
35 mm					
1/2 Reverse Cutting 	MK4658	1 4,0	75	12	Undyed
3/8 Reverse Cutting 	MK3932	2/0 3,0	75	12	Undyed
40 mm					
1/2 Round Body, Taper Point 	MK3981	2/0 3,0	75	12	Undyed
	MK4367	0 3,5	75	12	Undyed
	MK4374	0 3,5	90	12	Undyed
	MK4712	1 4,0	75	12	Undyed
	MK4713	1 4,0	75	12	Violet
	MK4718	1 4,0	90	12	Undyed
	MK5001	2 5,0	75	12	Undyed
1/2 Reverse Cutting 	MK4744	1 4,0	75	12	Undyed
	MK5018	2 5,0	75	12	Undyed
3/8 Reverse Cutting 	MK4407	0 3,5	75	12	Undyed
45 mm					
1/2 Round Body, Taper Point 	MK4771	1 4,0	75	12	Undyed
	MK5034	2 5,0	75	12	Undyed
50 mm					
1/2 Round Body, Taper Point 	MK4037	2/0 3,0	75	12	Undyed
	MK4811	1 4,0	75	12	Undyed

Monokaprol

Surgical Suture, Poly[glycolide(75%)-co-caprolactone(25%)](PGCL)
Absorbable, Synthetic, Monofilament

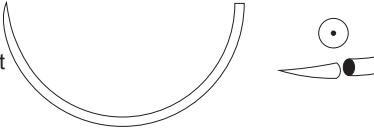
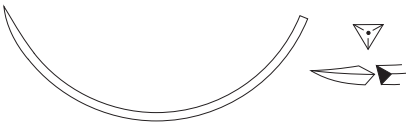
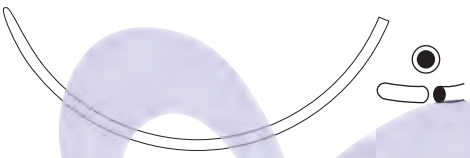
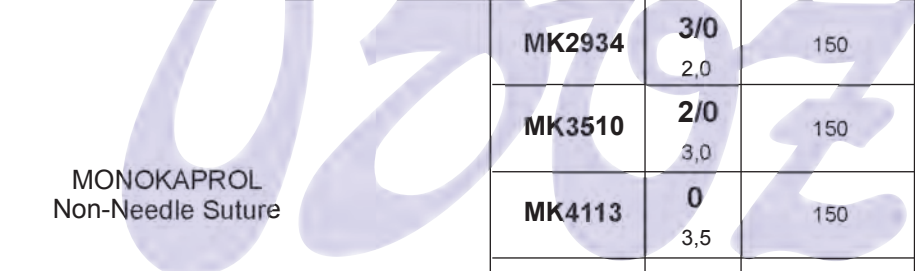
Needle Length and description	Product No	USP EP	Length (cm)	Unit Pcs	Color
50 mm					
1/2 Round Body, Taper Point 	MK4817	1 4,0	90	12	Undyed
	MK5065	2 5,0	75	12	Undyed
3/8 Reverse Cutting 	MK4474	0 3,5	75	12	Undyed
	MK4840	1 4,0	75	12	Undyed
63 mm					
3/8 Blunt 	MK4859	1 4,0	100	12	Undyed
	MK4857	1 4,0	75	12	Undyed
Non-Needle Suture	Product No	USP EP	Length (cm)	Unit	Color
150 cm					
MONOKAPROL Non-Needle Suture 	MK2934	3/0 2,0	150	12	Undyed
	MK3510	2/0 3,0	150	12	Undyed
	MK4113	0 3,5	150	12	Undyed
	MK4531	1 4,0	150	12	Undyed
	MK4907	2 5,0	150	12	Undyed

Surgical Sutures Absorbable

Polidiox

Surgical Suture, Polydioxanone (PDO) Absorbable,
Synthetic, Monofilament, Violet



Boz®



Definition

Synthetic absorbable, wound support through an extended healing period

Material

Polydioxanone (PDO)

Coating

No coating

Structure

Monofilament

Colour

Violet (dyed)

Size

EP : 0.5 to 5

USP : 7/0 to 2

Tensile Strength Retention

2. Week 70 %

Mass Absorption

180-240 days

Sterilization Method

Ethylene Oxide Gas

Main Indication

Orthopaedics

General Surgery

Abdominal Wall Closure

Paediatric cardiovascular tissues

Ophthalmic Surgery













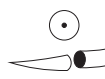

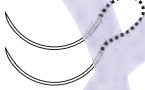
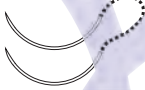
Polidiox

Surgical Suture, Polydioxanone (PDO) Absorbable, Synthetic, Monofilament, Violet

Needle Length and description			Product No	USP EP	Length (cm)	Unit Pcs	Color
8 mm							
3/8 Round Body, Taper Point 220 Micron			PX1289	7/0 0,5	45	12	Violet
3/8 Round Body, Taper Point 280 Micron			PX5444	7/0 0,5	45	12	Violet
3/8 Round Body, Taper Point 280 Micron			PX1426	6/0 0,7	45	12	Violet
10 mm							
3/8 Reverse Cutting 330 Micron			PX5850	6/0 0,7	45	12	Violet
11 mm							
3/8 Round Body, Taper Point 220 Micron			PX1509	6/0 0,7	45	12	Violet
13 mm							
1/2 Round Body, Taper Point 330 Micron			PX1564	6/0 0,7	75	12	Violet
1/2 Round Body, Taper Point 380 Micron			PX1885	5/0 1,0	75	12	Violet
1/2 Round Body, Taper Point 430 Micron			PX1897	5/0 1,0	75	12	Violet
1/2 Spatula 280 Micron			PX1599	6/0 0,7	45	12	Violet
3/8 Round Body, Taper Point 280 Micron			PX1362	7/0 0,5	45	12	Violet
3/8 Round Body, Taper Point 320 Micron			PX1575	6/0 0,7	45	12	Violet
3/8 Round Body, Taper Point 320 Micron			PX1576	6/0 0,7	45	12	Violet
3/8 Round Body, Taper Point 320 Micron			PX1128	6/0 0,7	75	12	Violet
3/8 Round Body, Taper Point 380 Micron			PX1914	5/0 0,7	75	12	Violet
3/8 Tapercutting 280 Micron			PX1609	6/0 0,7	45	12	Violet

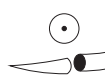









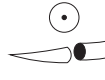

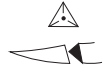

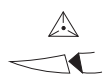

Polidiox

Surgical Suture, Polydioxanone (PDO) Absorbable, Synthetic, Monofilament, Violet

Needle Length and description			Product No	USP EP	Length (cm)	Unit Pcs	Color
16 mm							
1/2 Round Body, Taper Point 	 	PX1990	5/0 1,0	75	12	Violet	
		PX2504	4/0 1,5	75	12	Violet	
		PX3005	3/0 2,0	75	12	Violet	
1/2 Round Body, Taper Point 	 	PX1999	5/0 1,0	90	12	Violet	
		PX2513	4/0 1,5	90	12	Violet	
3/8 Round Body, Taper Point 	 	PX2005	5/0 1,0	75	12	Violet	
		PX2520	4/0 1,5	75	12	Violet	
3/8 Round Body, Taper Point 	 	PX2523	4/0 1,5	90	12	Violet	
3/8 Reverse Cutting 	 	PX2021	5/0 1,0	75	12	Violet	
		PX2540	4/0 1,5	75	12	Violet	
17 mm							
1/2 Round Body, Taper Point 	 	PX5517	5/0 1,0	75	12	Violet	
1/2 Round Body, Taper Point 	 	PX5516	4/0 1,5	75	12	Violet	
19 mm							
3/8 Reverse Cutting 	 	PX2635	4/0 1,5	45	12	Violet	
		PX3109	3/0 2,0	75	12	Violet	
20 mm							
1/2 Round Body, Taper Point 	 	PX2229	5/0 1,0	75	12	Violet	
		PX2685	4/0 1,5	75	12	Violet	

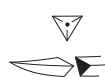

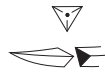
Polidiox

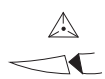
Surgical Suture, Polydioxanone (PDO) Absorbable, Synthetic, Monofilament, Violet

Needle Length and description			Product No	USP EP	Length (cm)	Unit Pcs	Color
20 mm							
1/2 Round Body, Taper Point			PX3142	3/0 2,0	75	12	Violet
1/2 Inside Cutting			PX3175	3/0 2,0	75	12	Violet
3/8 Reverse Cutting			PX2719	4/0 1,5	75	12	Violet
22 mm							
1/2 Inside Cutting			PX3217	3/0 2,0	45	12	Violet
25 mm							
1/2 Round Body, Taper Point			PX3252	3/0 2,0	75	12	Violet
			PX3724	2/0 3,0	75	12	Violet
			PX4190	0 3,5	75	12	Violet
26 mm							
1/2 Round Body, Taper Point			PX2828	4/0 1,5	75	12	Violet
			PX3313	3/0 2,0	75	12	Violet
			PX3786	2/0 3,0	75	12	Violet
1/2 Reverse Cutting			PX3336	3/0 2,0	75	12	Violet
			PX3813	2/0 3,0	75	12	Violet
3/8 Reverse Cutting			PX3341	3/0 2,0	45	12	Violet
			PX3346	3/0 2,0	75	12	Violet
3/8 Inside Cutting			PX3360	3/0 2,0	75	12	Violet

Polidiox

Surgical Suture, Polydioxanone (PDO) Absorbable, Synthetic, Monofilament, Violet

Needle Length and description	Product No	USP EP	Length (cm)	Unit Pcs	Color
30 mm					
1/2 Round Body, Taper Point 	PX3369	3/0 2,0	75	12	Violet
	PX3858	2/0 3,0	75	12	Violet
	PX4244	0 3,5	75	12	Violet
3/8 Reverse Cutting 	PX3891	2/0 3,0	75	12	Violet

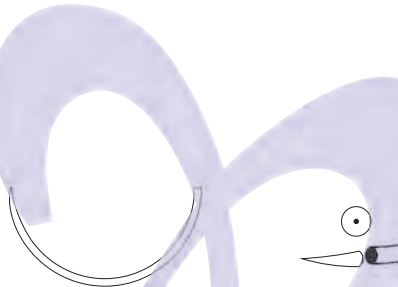
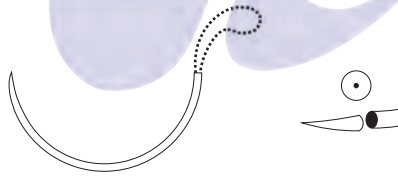
40 mm					
1/2 Round Body, Taper Point 	PX3982	2/0 3,0	75	12	Violet
	PX4368	0 3,5	75	12	Violet
	PX4713	1 4,0	75	12	Violet
	PX4719	1 4,0	90	12	Violet
	PX5006	2 5,0	90	12	Violet
1/2 Round Body, Taper Point LOOP 	PX4388	0 3,5	150	12	Violet
	PX4736	1 4,0	150	12	Violet

45 mm					
1/2 Round Body, Taper Point Heavy 	PX4779	1 4,0	90	12	Violet

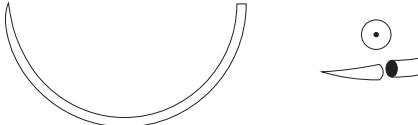
50 mm					
1/2 Round Body Taper Point 	PX4459	0 3,5	90	12	Violet
	PX4818	1 4,0	90	12	Violet
	PX5070	2 5,0	90	12	Violet

Polidiox

Surgical Suture, Polydioxanone (PDO) Absorbable, Synthetic, Monofilament, Violet

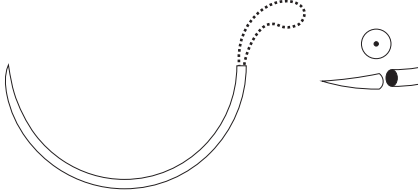
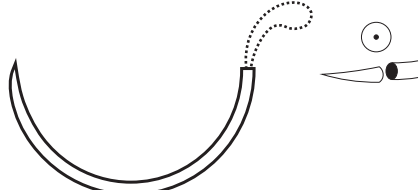
Needle Length and description	Product No	USP EP	Length (cm)	Unit Pcs	Color
50 mm					
<p>1/2 Round Body, Taper Point LOOP</p> 	PX4827	1 4,0	150	12	Violet
<p>1/2 Round Body, Taper Point Heavy, LOOP</p> 	PX4466	0 3,5	150	12	Violet

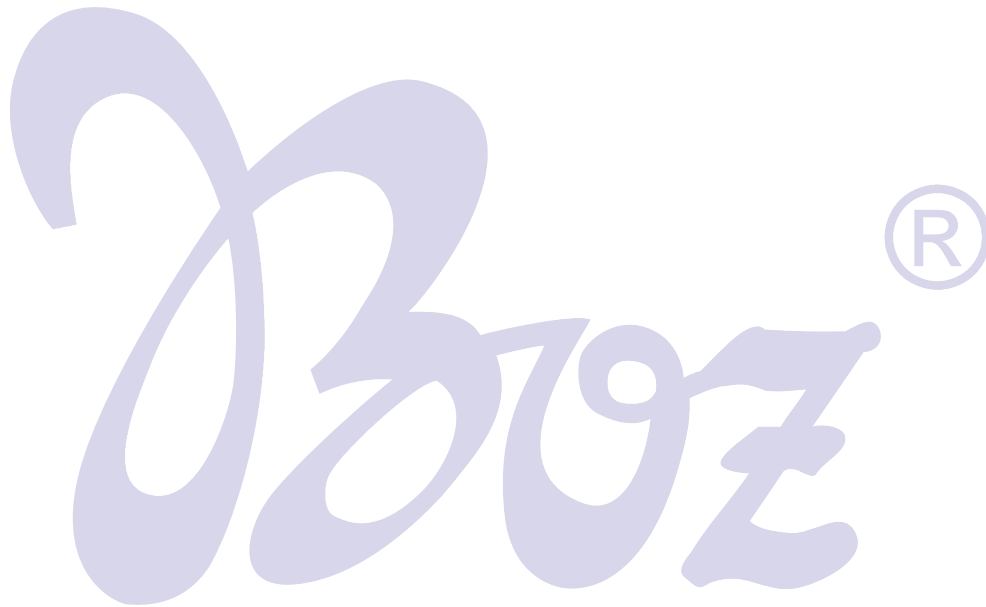



Boz Medical Device Industry and Trade Inc.

Antibacterial Absorbable Sutures

GLIKOSORB Plus

GLIKOLAK Plus

MONOKAPROL Plus

POLIDIOX Plus

web : www.boztibbi.com
email: boz@boztibbi.com

Surgical Sutures
Absorbable

Antibacterial Glikosorb Plus

Surgical Suture, Polyglycolic acid (PGA) Absorbable, Synthetic, Braided

Boz[®]



Definition

Synthetic absorbable, coated, antibacterial mid term wound support and mid term mass absorption.

Material

Polyglycolic Acid (PGA)

Antibacterial Agent

CHA (Chlorhexidine diacetate)

Coating

Calcium Stearate and poly(glycolide-co-lactide)

Structure

Braided - Multifilament

Colour

Violet (dyed)

Size

EP : 1 to 5

USP : 5/0 to 2

Tensile Strength Retention

2. Week 90 % - 3. Week 50 %

Mass Absorption

70-90 days

Sterilization Method

Ethylene Oxide Gas

Main Indication

Gastrointestinal Surgery

Gynaecology

Orthopedics















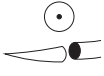

Urology

Skin closer - intracutaneous, subcutaneous.

Ligatures

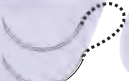

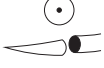









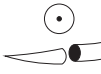

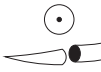
Antibacterial Glikosorb Plus

Surgical Suture, Polyglycolic acid (PGA)
Absorbable, Synthetic, Braided

Needle Length and description	Product No	USP EP	Length (cm)	Unit Pcs	Color	
8 mm						
1/4 Spatula 430 Micron	 	GSP2363	4/0 1,5	45	12	Violet
3/8 Spatula 280 Micron	 	GSP1768	5/0 1,0	45	12	Violet
3/8 Spatula 340 Micron	 	GSP1764	5/0 1,0	45	12	Violet
13 mm						
1/2 Round Body, Taper Point 430 Micron	 	GSP1897	5/0 1,0	75	12	Violet
3/8 Round Body, Taper Point 380 Micron	 	GSP1914	5/0 1,0	75	12	Violet
3/8 Round Body, Taper Point 430 Micron	 	GSP1894	5/0 1,0	75	12	Violet
		GSP2434	4/0 1,5	60	12	Violet
		GSP2436	4/0 1,5	75	12	Violet
3/8 Reverse Cutting 560 Micron	 	GSP2456	4/0 1,5	75	12	Violet
3/8 Spatula 330 Micron	 	GSP1873	5/0 1,0	60	12	Violet
16 mm						
1/2 Round Body, Taper Point	 	GSP1992	5/0 1,0	75	12	Undyed
		GSP2503	4/0 1,5	75	12	Undyed
		GSP3005	3/0 2,0	75	12	Violet
3/8 Reverse Cutting	 	GSP2021	5/0 1,0	75	12	Violet
		GSP2540	4/0 1,5	75	12	Violet
		GSP3025	3/0 2,0	75	12	Violet

Antibacterial Glikosorb Plus

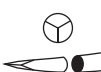
Surgical Suture, Polyglycolic acid (PGA)
Absorbable, Synthetic, Braided

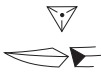
Needle Length and description			Product No	USP EP	Length (cm)	Unit Pcs	Color
16 mm							
3/8 Inside Cutting			GSP2140	5/0 1,0	45	12	Violet
			GSP2557	4/0 1,5	75	12	Undyed
			GSP3039	3/0 2,0	75	12	Violet
18 mm							
1/2 Round Body, Taper Point			GSP2613	4/0 1,5	75	12	Violet
3/8 Round Body, Taper Point			GSP3085	3/0 2,0	75	12	Violet
19 mm							
1/2 Round Body, Taper Point			GSP2197	5/0 1,0	75	12	Violet
3/8 Reverse Cutting			GSP2206	5/0 1,0	75	12	Violet
			GSP2640	4/0 1,5	75	12	Violet
3/8 Reverse Cutting Premium			GSP2211	5/0 1,0	45	12	Violet
20 mm							
1/2 Round Body, Taper Point			GSP2229	5/0 1,0	75	12	Violet
			GSP2685	4/0 1,5	75	12	Violet
			GSP3142	3/0 2,0	75	12	Violet
1/2 Tapercutting			GSP2673	4/0 1,5	75	12	Violet
3/8 Reverse Cutting			GSP2250	5/0 1,0	75	12	Undyed
			GSP2716	4/0 1,5	45	12	Undyed
			GSP2719	4/0 1,5	75	12	Violet

Antibacterial Glikosorb Plus

Surgical Suture, Polyglycolic acid (PGA)
Absorbable, Synthetic, Braided

Needle Length and description	Product No	USP EP	Length (cm)	Unit Pcs	Color
20 mm					
3/8 Reverse Cutting  	GSP3168	3/0 2,0	75	12	Violet
	GSP3663	2/0 3,0	75	12	Violet
22 mm					
1/2 Round Body, Taper Point  	GSP2747	4/0 1,5	75	12	Violet
3/8 Reverse Cutting  	GSP3214	3/0 2,0	90	12	Violet
25 mm					
1/2 Round Body, Taper Point  	GSP2788	4/0 1,5	75	12	Violet
	GSP3252	3/0 2,0	75	12	Violet
	GSP3746	2/0 3,0	100	12	Violet
	GSP3724	2/0 3,0	75	12	Violet
1/2 Tapercutting  	GSP3718	2/0 3,0	75	12	Violet
3/8 Reverse Cutting  	GSP2804	4/0 1,5	75	12	Violet
	GSP3274	3/0 2,0	75	12	Violet
	GSP3757	2/0 3,0	75	12	Violet
3/8 Inside Cutting  	GSP2812	4/0 1,5	45	12	Violet
	GSP3284	3/0 2,0	45	12	Violet
26 mm					
1/2 Round Body, Taper Point  	GSP2292	5/0 1,0	75	12	Violet
	GSP2828	4/0 1,5	75	12	Violet





Antibacterial Glikosorb Plus

Surgical Suture, Polyglycolic acid (PGA)
Absorbable, Synthetic, Braided

Needle Length and description	Product No	USP EP	Length (cm)	Unit Pcs	Color
26 mm					
1/2 Round Body, Taper Point 	GSP3313	3/0 2,0	75	12	Violet
	GSP3318	3/0 2,0	90	12	Violet
	GSP3786	2/0 3,0	75	12	Violet
3/8 Round Body, Taper Point 	GSP2841	4/0 1,5	75	12	Violet
3/8 Reverse Cutting 	GSP3345	3/0 2,0	75	12	Undyed
	GSP3346	3/0 2,0	75	12	Violet
	GSP3821	2/0 3,0	75	12	Undyed
	GSP3822	2/0 3,0	75	12	Violet
30 mm					
1/2 Round Body, Taper Point 	GSP3858	2/0 3,0	75	12	Violet
	GSP4244	0 3,5	75	12	Violet
	GSP4608	1 4,0	75	12	Violet
1/2 Reverse Cutting 	GSP3882	2/0 3,0	75	12	Violet
	GSP4266	0 3,5	75	12	Violet
1/2 Taper cutting 	GSP3843	2/0 3,0	75	12	Violet
3/8 Reverse Cutting 	GSP2887	4/0 1,5	75	12	Violet
	GSP3397	3/0 2,0	75	12	Violet
	GSP3891	2/0 3,0	75	12	Violet
	GSP4273	0 3,5	75	12	Violet



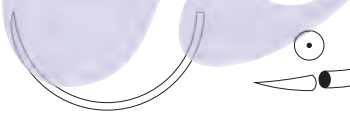



Antibacterial Glikosorb Plus

Surgical Suture, Polyglycolic acid (PGA)
Absorbable, Synthetic, Braided

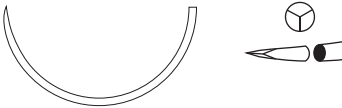
Needle Length and description	Product No	USP EP	Length (cm)	Unit Pcs	Color
35 mm					
1/2 Round Body, Taper Point 	GSP3411	3/0 2,0	75	12	Violet
	GSP3916	2/0 3,0	75	12	Violet
	GSP3922	2/0 3,0	90	12	Violet
	GSP4300	0 3,5	75	12	Violet
	GSP4644	1 4,0	75	12	Violet
3/8 Reverse Cutting 	GSP3423	3/0 2,0	75	12	Violet
	GSP3933	2/0 3,0	75	12	Violet
40 mm					
1/2 Round Body, Taper Point 	GSP3982	2/0 3,0	75	12	Violet
	GSP4368	0 3,5	75	12	Violet
	GSP4375	0 3,5	90	12	Violet
	GSP4713	1 4,0	75	12	Violet
	GSP4719	1 4,0	90	12	Violet
	GSP5003	2 5,0	75	12	Violet
	GSP5006	2 5,0	90	12	Violet
1/2 Reverse Cutting 	GSP4397	0 3,5	75	12	Violet
	GSP4745	1 4,0	75	12	Violet
	GSP4749	1 4,0	90	12	Violet
	GSP5023	2 5,0	90	12	Violet

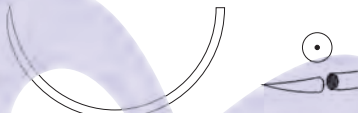
Antibacterial Glikosorb Plus

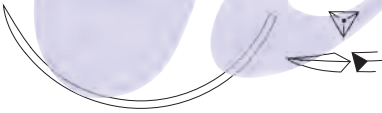
Surgical Suture, Polyglycolic acid (PGA)
Absorbable, Synthetic, Braided

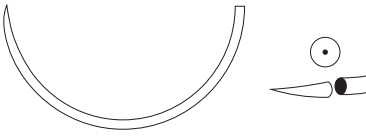
Needle Length and description	Product No	USP EP	Length (cm)	Unit Pcs	Color
40 mm					
1/2 Tapercutting 	GSP4363	0 3,5	75	12	Violet
3/8 Reverse Cutting 	GSP4408	0 3,5	75	12	Violet
	GSP4756	1 4,0	75	12	Violet
45 mm					
1/2 Round Body, Taper Point 	GSP4422	0 3,5	75	12	Violet
	GSP4772	1 4,0	75	12	Violet
	GSP5035	2 5,0	75	12	Violet
	GSP5040	2 5,0	90	12	Violet
1/2 Tapercutting 	GSP4766	1 4,0	75	12	Violet
3/8 Reverse Cutting 	GSP4432	0 3,5	75	12	Violet
	GSP4787	1 4,0	75	12	Violet
Straight Reverse Cutting 	GSP2909	4/0 1,5	45	12	Violet
50 mm					
1/2 Round Body, Taper Point 	GSP4454	0 3,5	75	12	Violet
	GSP4459	0 3,5	90	12	Violet
	GSP4812	1 4,0	75	12	Violet
	GSP4818	1 4,0	90	12	Violet

Antibacterial Glikosorb Plus

Surgical Suture, Polyglycolic acid (PGA)
Absorbable, Synthetic, Braided

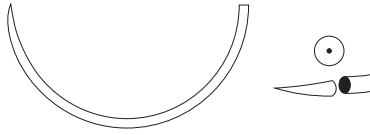
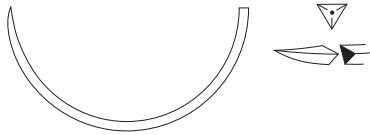
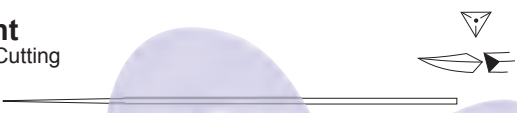
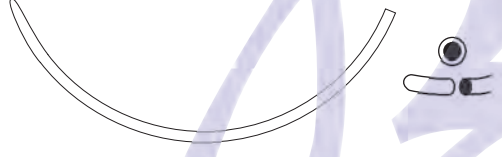
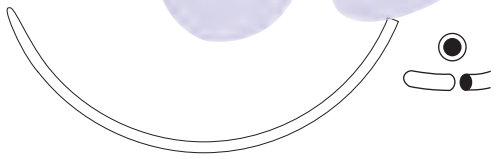
Needle Length and description	Product No	USP EP	Length (cm)	Unit Pcs	Color
50 mm					
1/2 Round Body, Taper Point 	GSP5066	2 5,0	75	12	Violet
	GSP5070	2 5,0	90	12	Violet
1/2 Reverse Cutting 	GSP4471	0 3,5	75	12	Violet
60 mm					
Straight Reverse Cutting 	GSP3492	3/0 2,0	75	12	Violet
	GSP4074	2/0 3,0	75	12	Violet
63 mm					
3/8 Blunt 	GSP4858	1 4,0	75	12	Violet
64 mm					
3/8 Blunt 	GSP4500	0 3,5	90	12	Violet
	GSP4861	1 4,0	90	12	Violet

Antibacterial

Glikosorb Plus

Surgical Suture, Polyglycolic acid (PGA)
Absorbable, Synthetic, Braided

Non-Needle Suture	Product No	USP EP	Length (cm)	Unit Pcs	Color
6x45 cm					
GLIKOSORB Plus Non-Needle Suture	GSP2950	3/0 2,0	6x45	12	Violet
	GSP3543	2/0 3,0	6x45	12	Violet
	GSP4137	0 3,5	6x45	12	Violet
	GSP4563	1 4,0	6x45	12	Violet
12x45 cm					
GLIKOSORB Plus Non-Needle Suture	GSP2344	4/0 1,5	12x45	12	Violet
	GSP2958	3/0 2,0	12x45	12	Violet
	GSP3552	2/0 3,0	12x45	12	Violet
	GSP4145	0 3,5	12x45	12	Violet
7x75 cm					
GLIKOSORB Plus Non-Needle Suture	GSP2952	3/0 2,0	7x75	12	Violet
10x75 cm					
GLIKOSORB Plus Non-Needle Suture	GSP4550	1 4,0	10x75	12	Violet
150 cm					
GLIKOSORB Plus Non-Needle Suture	GSP1737	5/0 1,0	150	12	Violet
	GSP2326	4/0 1,5	150	12	Violet
	GSP2935	3/0 2,0	150	12	Violet
	GSP3511	2/0 3,0	150	12	Violet
	GSP4114	0 3,5	150	12	Violet
	GSP4532	1 4,0	150	12	Violet

Surgical Sutures Absorbable

Antibacterial Glikolak Plus

Surgical Suture, Poly[glycolide(90%)-co-lactide(10%)](PGLA)
Absorbable, Synthetic, Braided

Boz®



Definition

Synthetic absorbable, coated, antibacterial mid term wound support and mid term mass absorption.

Material

Poly(glycolide-co-lactide)
glycolide 90% -lactide 10 % (PGLA)

Antibacterial Agent:

CHA (Chlorhexidine diacetate)

Coating

Poly(glycolide-co-lactide) & calcium stearate

Structure

Braided-Multifilament

Colour

Beige (undyed) or Violet (dyed)

Size

EP : 1 to 5
USP : 5/0 to 2

Tensile Strength Retention

2. Week 75%

Mass Absorption

55-70 days

Sterilization Method

Ethylene Oxide Gas





















Main Indication

Gastrointestinal Surgery
Gynaecology
Orthopedics
Urology
Skin closer - intracutaneous, subcutaneous.
Ligatures

Antibacterial

Glikolak Plus

Surgical Suture, Poly[glycolide(90%)-co-lactide(10%)](PGLA)
Absorbable, Synthetic, Braided

Needle Length and description	Product No	USP EP	Length (cm)	Unit Pcs	Color	
8 mm						
1/4 Spatula 340 Micron	 	GLP1764	5/0 1,0	45	12	Violet
3/8 Spatula 230 Micron	 	GLP1768	5/0 1,0	45	12	Violet
3/8 Round Body, Taper Point 380 Micron	 	GLP1778	5/0 1,0	75	12	Violet
13 mm						
1/2 Round Body, Taper Point 380 Micron	 	GLP1885	5/0 1,0	75	12	Violet
1/2 Round Body, Taper Point 430 Micron	 	GLP1897	5/0 1,0	75	12	Violet
3/8 Round Body, Taper Point 380 Micron	 	GLP1914	5/0 1,0	75	12	Violet
3/8 Round Body, Taper Point 430 Micron	 	GLP2434	4/0 1,5	60	12	Violet
3/8 Round Body, Taper Point 430 Micron	 	GLP2436	4/0 1,5	75	12	Violet
3/8 Reverse Cutting 380 Micron	 	GLP1928	5/0 1,0	75	12	Violet
16 mm						
1/2 Round Body, Taper Point	 	GLP1990	5/0 1,0	75	12	Violet
		GLP2504	4/0 1,5	75	12	Violet
		GLP3005	3/0 2,0	75	12	Violet
3/8 Reverse Cutting	 	GLP2021	5/0 1,0	75	12	Violet
		GLP2540	4/0 1,5	75	12	Violet
		GLP3025	3/0 2,0	75	12	Violet
3/8 Inside Cutting	 	GLP2144	5/0 1,0	75	12	Violet
		GLP2553	4/0 1,5	45	12	Violet

Antibacterial

Glikolak Plus

Surgical Suture, Poly[glycolide(90%)-co-lactide(10%)](PGLA)
Absorbable, Synthetic, Braided

Needle Length and description	Product No	USP EP	Length (cm)	Unit Pcs	Color
16 mm					
3/8 Inside Cutting  	GLP2557	4/0 1,5	75	12	Undyed
	GLP3039	3/0 2,0	75	12	Violet
18 mm					
1/2 Round Body, Taper Point  	GLP2613	4/0 1,5	75	12	Violet
19 mm					
3/8 Reverse Cutting  	GLP2206	5/0 1,0	75	12	Violet
	GLP2640	4/0 1,5	75	12	Violet
20 mm					
1/2 Round Body, Taper Point  	GLP2229	5/0 1,0	75	12	Violet
	GLP2685	4/0 1,5	75	12	Violet
	GLP2690	4/0 1,5	90	12	Violet
	GLP3142	3/0 2,0	75	12	Violet
3/8 Reverse Cutting  	GLP2716	4/0 1,5	45	12	Undyed
	GLP3164	3/0 2,0	45	12	Violet
	GLP3168	3/0 2,0	75	12	Violet
22 mm					
3/8 Reverse Cutting  	GLP2763	4/0 1,5	75	12	Violet
25 mm					
1/2 Round Body, Taper Point  	GLP2788	4/0 1,5	75	12	Violet
	GLP3252	3/0 2,0	75	12	Violet

Antibacterial

Glikolak Plus





Surgical Suture, Poly[glycolide(90%)-co-lactide(10%)](PGLA)
Absorbable, Synthetic, Braided

Needle Length and description	Product No	USP EP	Length (cm)	Unit Pcs	Color
25 mm					
1/2 Round Body, Taper Point 	GLP3746	2/0 3,0	100	12	Violet
	GLP3724	2/0 3,0	75	12	Violet
3/8 Reverse Cutting 	GLP2804	4/0 1,5	75	12	Violet
3/8 Inside Cutting 	GLP2812	4/0 1,5	45	12	Violet
	GLP3284	3/0 2,0	45	12	Violet
	GLP3763	2/0 3,0	75	12	Violet
26 mm					
1/2 Round Body, Taper Point 	GLP2828	4/0 1,5	75	12	Violet
	GLP3313	3/0 2,0	75	12	Violet
	GLP3786	2/0 3,0	75	12	Violet
	GLP4220	0 3,5	90	12	Violet
3/8 Reverse Cutting 	GLP2852	4/0 1,5	75	12	Violet
	GLP3346	3/0 2,0	75	12	Violet
	GLP3822	2/0 3,0	75	12	Violet
30 mm					
1/2 Round Body, Taper Point 	GLP3369	3/0 2,0	75	12	Violet
	GLP3858	2/0 3,0	75	12	Violet
	GLP3865	2/0 3,0	90	12	Violet
	GLP4244	0 3,5	75	12	Violet

Antibacterial

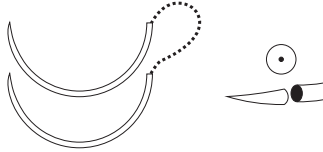
Glikolak Plus

Surgical Suture, Poly[glycolide(90%)-co-lactide(10%)](PGLA)
Absorbable, Synthetic, Braided

Needle Length and description	Product No	USP EP	Length (cm)	Unit Pcs	Color
30 mm					
1/2 Round Body, Taper Point 	GLP4250	0 3,5	90	12	Violet
	GLP4608	1 4,0	75	12	Violet
	GLP4614	1 4,0	90	12	Violet
1/2 Round Body, Taper Point 	GLP3854	2/0 3,0	75	12	Violet
3/8 Reverse Cutting 	GLP3397	3/0 2,0	75	12	Violet
	GLP3891	2/0 3,0	75	12	Violet
	GLP3895	2/0 3,0	90	12	Violet
	GLP4273	0 3,5	75	12	Violet
35 mm					
1/2 Round Body, Taper Point 	GLP3411	3/0 2,0	75	12	Violet
	GLP3916	2/0 3,0	75	12	Violet
	GLP4300	0 3,5	75	12	Violet
	GLP4644	1 4,0	75	12	Violet
	GLP4649	1 4,0	90	12	Violet
3/8 Reverse Cutting 	GLP3423	3/0 2,0	75	12	Violet
	GLP3933	2/0 3,0	75	12	Violet
3/8 Inside Cutting 	GLP3938	2/0 3,0	75	12	Violet

Antibacterial**Glikolak Plus**Surgical Suture, Poly[glycolide(90%)-co-lactide(10%)](PGLA)
Absorbable, Synthetic, Braided

Needle Length and description	Product No	USP EP	Length (cm)	Unit Pcs	Color
40 mm					
1/2 Round Body, Taper Point 	GLP3982	2/0 3,0	75	12	Violet
	GLP4368	0 3,5	75	12	Violet
	GLP4375	0 3,5	90	12	Violet
	GLP4713	1 4,0	75	12	Violet
	GLP4719	1 4,0	90	12	Violet
	GLP5003	2 5,0	75	12	Violet
1/2 Reverse Cutting 	GLP4399	0 3,5	90	12	Violet
	GLP4749	1 4,0	90	12	Violet
3/8 Reverse Cutting 	GLP4756	1 4,0	75	12	Violet
45 mm					
1/2 Round Body, Taper Point 	GLP4422	0 3,5	75	12	Violet
	GLP4772	1 4,0	75	12	Violet
	GLP4775	1 4,0	90	12	Violet
	GLP5035	2 5,0	75	12	Violet
3/8 Reverse Cutting 	GLP4787	1 4,0	75	12	Violet
50 mm					
1/2 Round Body, Taper Point 	GLP4454	0 3,5	75	12	Violet
	GLP4459	0 3,5	90	12	Violet

Antibacterial

Glikolak Plus

Surgical Suture, Poly[glycolide(90%)-co-lactide(10%)](PGLA)
Absorbable, Synthetic, Braided

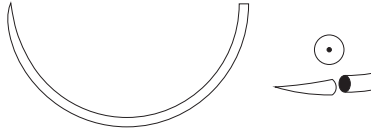
Needle Length and description	Product No	USP EP	Length (cm)	Unit Pcs	Color
50 mm					
1/2 Round Body, Taper Point 	GLP4812	1 4,0	75	12	Violet
	GLP4818	1 4,0	90	12	Violet
	GLP5066	2 5,0	75	12	Violet
	GLP5070	2 5,0	90	12	Violet

60 mm					
Straight Reverse Cutting 	GLP2923	4/0 1,5	75	12	Violet
	GLP3492	3/0 2,0	75	12	Violet
	GLP3498	3/0 2,0	90	12	Violet
	GLP4074	2/0 3,0	75	12	Violet

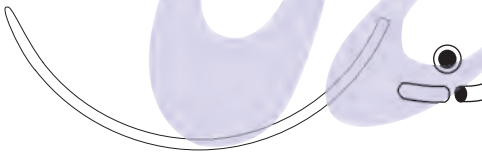
63 mm					
3/8 Blunt 	GLP4085	2/0 3,0	75	12	Violet
	GLP4858	1 4,0	75	12	Violet

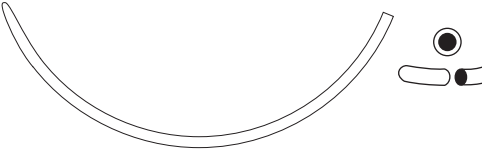
64 mm					
3/8 Blunt 	GLP4861	1 4,0	90	12	Violet

Antibacterial**Glikolak Plus**Surgical Suture, Poly[glycolide(90%)-co-lactide(10%)](PGLA)
Absorbable, Synthetic, Braided

Non-Needle Suture	Product No	USP EP	Length (cm)	Unit Pcs	Color
6x45 cm					
GLIKOLAK Plus Non-Needle Suture	GLP2950	3/0 2,0	6x45	12	Violet
	GLP4137	0 3,5	6x45	12	Violet

12x45 cm					
GLIKOLAK Plus Non-Needle Suture	GLP2344	4/0 1,5	12x45	12	Violet
	GLP2958	3/0 2,0	12x45	12	Violet
	GLP3552	2/0 3,0	12x45	12	Violet
	GLP4145	0 3,5	12x45	12	Violet

17x45 cm					
GLIKOLAK Plus Non-Needle Suture	GLP2349	4/0 1,5	17x45	12	Violet
	GLP2966	3/0 2,0	17x45	12	Violet
	GLP3558	2/0 3,0	17x45	12	Violet
	GLP4149	0 3,5	17x45	12	Violet

10x50 cm					
GLIKOLAK Plus Non-Needle Suture	GLP3547	2/0 3,0	10x50	12	Violet
	GLP4140	0 3,5	10x50	12	Violet
	GLP4549	1 4,0	10x50	12	Violet

7x75 cm					
GLIKOLAK Plus Non-Needle Suture	GLP2952	3/0 2,0	7x75	12	Violet
	GLP3545	2/0 3,0	7x75	12	Violet
	GLP4139	0 3,5	7x75	12	Violet

Antibacterial**Glikolak Plus**Surgical Suture, Poly[glycolide(90%)-co-lactide(10%)](PGLA)
Absorbable, Synthetic, Braided

Non-Needle Suture	Product No	USP EP	Length (cm)	Unit Pcs	Color
10x75 cm					
GLIKOLAK Plus Non-Needle Suture	GLP2341	4/0 1,5	10x75	12	Violet
	GLP4141	0 3,5	10x75	12	Violet

150 cm					
GLIKOLAK Plus Non-Needle Suture	GLP1737	5/0 1,0	150	12	Violet
	GLP2326	4/0 1,5	150	12	Violet
	GLP2934	3/0 2,0	150	12	Undyed
	GLP2935	3/0 2,0	150	12	Violet
	GLP3511	2/0 3,0	150	12	Violet
	GLP4114	0 3,5	150	12	Violet

Surgical Sutures Absorbable

Antibacterial Monokaprol Plus

Surgical Suture, Poly[glycolide(75%)-co-caprolactone(25%)](PGCL)
Absorbable, Synthetic, Monofilament



Boz®

®

Definition

Synthetic absorbable, antibacterial, closure of superficial wounds

Material

Poly(glycolide (75%)- co-caprolactone (25%) (PGCL)

Antibacterial Agent:

CHA (Chlorhexidine diacetate)

Coating

No coating

Structure

Monofilament

Colour

Undyed Beige (undyed) or Violet (dyed)

Size

EP : 1 to 5

USP : 5/0 to 2

Tensile Strength Retention

1. Week 70 % - 75 % - 2. Week 40 % - 50%

Mass Absorption

90 - 120 Days

Sterilization Method

Ethylene Oxide Gas

Main Indication

Gynaecology

Obstetrics

Urology











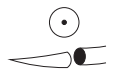

Plastic Surgery

Odontology (oral mucosa)

Skin closer - intracutaneous, subcutaneous.

Antibacterial Monokaprol Plus

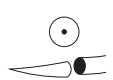
Surgical Suture, Poly[glycolide(75%)-co-caprolactone(25%)](PGCL)
Absorbable, Synthetic, Monofilament

Needle Length and description	Product No	USP EP	Length (cm)	Unit Pcs	Color	
8 mm						
1/4 Spatula 330 Micron	 	MKP1759	5/0 1,0	45	12	Undyed
13 mm						
3/8 Round Body, Taper Point 330 Micron	 	MKP1905	5/0 1,0	50	12	Undyed
16 mm						
1/2 Round Body, Taper Point	 	MKP1985	5/0 1,0	45	12	Undyed
		MKP1989	5/0 1,0	75	12	Undyed
		MKP2503	4/0 1,5	75	12	Undyed
		MKP3004	3/0 2,0	75	12	Undyed
3/8 Reverse Cutting	 	MKP2019	5/0 1,0	75	12	Undyed
		MKP2539	4/0 1,5	75	12	Undyed
3/8 Inside Cutting	 	MKP2139	5/0 1,0	45	12	Undyed
		MKP2557	4/0 1,5	75	12	Undyed
		MKP3038	3/0 2,0	75	12	Undyed
19 mm						
3/8 Reverse Cutting	 	MKP2639	4/0 1,5	75	12	Undyed
		MKP3108	3/0 2,0	75	12	Undyed
20 mm						
1/2 Round Body, Taper Point	 	MKP2683	4/0 1,5	75	12	Undyed
		MKP3141	3/0 2,0	75	12	Undyed
3/8 Reverse Cutting	 	MKP2718	4/0 1,5	75	12	Undyed
		MKP3167	3/0 2,0	75	12	Undyed





Antibacterial Monokaprol Plus

Surgical Suture, Poly[glycolide(75%)-co-caprolactone(25%)](PGCL)
Absorbable, Synthetic, Monofilament

Needle Length and description	Product No	USP EP	Length (cm)	Unit Pcs	Color
25 mm					
1/2 Round Body, Taper Point 	MKP2787	4/0 1,5	75	12	Undyed
	MKP3251	3/0 2,0	75	12	Undyed
	MKP3723	2/0 3,0	75	12	Undyed
3/8 Inside Cutting 	MKP3762	2/0 3,0	75	12	Undyed
26 mm					
1/2 Round Body, Taper Point 	MKP3312	3/0 2,0	75	12	Undyed
	MKP3785	2/0 3,0	75	12	Undyed
1/2 Reverse Cutting 	MKP3335	3/0 2,0	75	12	Undyed
30 mm					
1/2 Round Body, Taper Point 	MKP3368	3/0 2,0	75	12	Undyed
	MKP3857	2/0 3,0	75	12	Undyed
	MKP4243	0 3,5	75	12	Undyed
	MKP4249	0 3,5	90	12	Undyed
	MKP4607	1 4,0	75	12	Undyed
1/2 Round Body, Taper Point 	MKP3853	2/0 3,0	75	12	Undyed
1/2 Reverse Cutting 	MKP4265	0 3,5	75	12	Undyed
3/8 Round Body, Taper Point 	MKP4263	0 3,5	75	12	Undyed

Antibacterial Monokaprol Plus



Surgical Suture, Poly[glycolide(75%)-co-caprolactone(25%)](PGCL)
Absorbable, Synthetic, Monofilament

Needle Length and description	Product No	USP EP	Length (cm)	Unit Pcs	Color
30 mm					
3/8 Reverse Cutting 	MKP3890	2/0 3,0	75	12	Undyed
	MKP4272	0 3,5	75	12	Undyed
35 mm					
1/2 Round Body, Taper Point 	MKP3915	2/0 3,0	75	12	Undyed
	MKP4299	0 3,5	75	12	Undyed
	MKP4643	1 4,0	75	12	Undyed
3/8 Reverse Cutting 	MKP3932	2/0 3,0	75	12	Undyed
	MKP4319	0 3,5	75	12	Undyed
40 mm					
1/2 Round Body, Taper Point 	MKP3981	2/0 3,0	75	12	Undyed
	MKP4367	0 3,5	75	12	Undyed
	MKP4374	0 3,5	90	12	Undyed
	MKP4723	1 4,0	100	12	Undyed
	MKP4712	1 4,0	75	12	Undyed
	MKP4718	1 4,0	90	12	Undyed
	MKP5001	2 5,0	75	12	Undyed
1/2 Reverse Cutting 	MKP4744	1 4,0	75	12	Undyed
	MKP5018	2 5,0	75	12	Undyed

Antibacterial Monokaprol Plus

Surgical Suture, Poly[glycolide(75%)-co-caprolactone(25%)](PGCL)
Absorbable, Synthetic, Monofilament

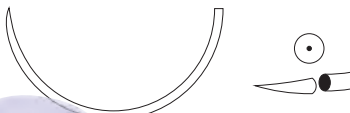
Needle Length and description	Product No	USP EP	Length (cm)	Unit Pcs	Color
40 mm					
3/8 Reverse Cutting 	MKP4407	0 3,5	75	12	Undyed
	MKP4755	1 4,0	75	12	Undyed

45 mm					
1/2 Round Body, Taper Point 	MKP4421	0 3,5	75	12	Undyed
	MKP4771	1 4,0	75	12	Undyed
3/8 Reverse Cutting 	MKP4431	0 3,5	75	12	Undyed

50 mm					
1/2 Round Body, Taper Point 	MKP4037	2/0 3,0	75	12	Undyed
	MKP4453	0 3,5	75	12	Undyed
	MKP4811	1 4,0	75	12	Undyed

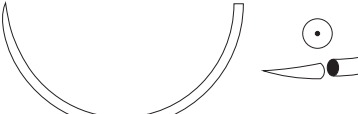
50 mm					
1/2 Round Body, Taper Point 	MKP4817	1 4,0	90	12	Undyed
	MKP5065	2 5,0	75	12	Undyed

63 mm					
3/8 Blunt 	MKP4857	1 4,0	75	12	Undyed

Antibacterial Monokaprol Plus

Surgical Suture, Poly[glycolide(75%)-co-caprolactone(25%)](PGCL)
Absorbable, Synthetic, Monofilament

Non-Needle Suture	Product No	USP EP	Length (cm)	Unit Pcs	Color
150 cm					
MONOKAPROL Plus Non-Needle Suture	MKP2934	3/0 2,0	150	12	Undyed
	MKP3510	2/0 3,0	150	12	Undyed
	MKP4113	0 3,5	150	12	Undyed
	MKP4531	1 4,0	150	12	Undyed
	MKP4907	2 5,0	150	12	Undyed

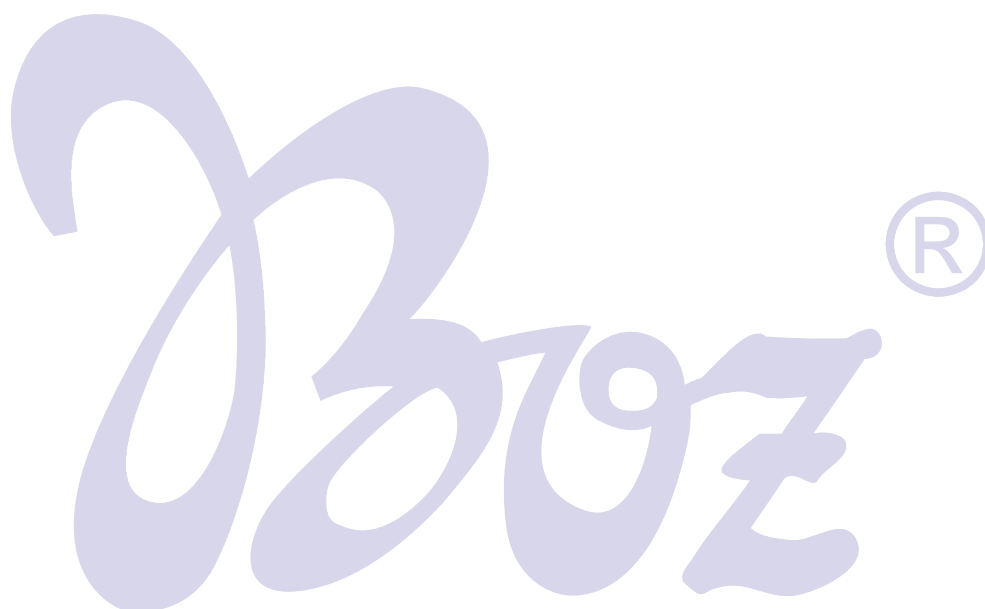

Antibacterial Polidiox Plus

Surgical Suture, Polydioxanone (PDO) Absorbable,
Synthetic, Monofilament, Violet

Surgical Sutures
Absorbable

BOZ[®]



Definition

Short-term synthetic absorbable, antibacterial, wound support through an extended healing period.

Material

Polydioxanone (PDO)

Antibacterial Agent:

CHA (Chlorhexidine diacetate)

Coating

No coating

Structure

Monofilament

Colour

Violet (dyed)

Size

EP : 1 to 5

USP : 5/0 to 2

Tensile Strength Retention

2. Week 70%

4. Week 50%

Mass Absorption

180 - 240 Days

Sterilization Method

Ethylene Oxide Gas

Main Indication











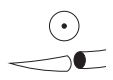

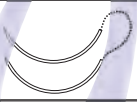

Orthopaedics

General Surgery

Abdominal Wall Closure

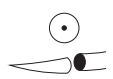









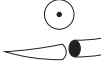

Antibacterial Polidiox Plus

Surgical Suture, Polydioxanone (PDO)
Absorbable, Synthetic, Monofilament, Violet

Needle Length and description	Product No	USP EP	Length (cm)	Unit Pcs	Color	
13 mm						
1/2 Round Body, Taper Point 430 Micron	 	PXP1897	5/0 1,0	75	12	Violet
16 mm						
1/2 Round Body, Taper Point	 	PXP1990	5/0 1,0	75	12	Violet
		PXP2504	4/0 1,5	75	12	Violet
		PXP3005	3/0 2,0	75	12	Violet
1/2 Round Body, Taper Point	 	PXP1999	5/0 1,0	90	12	Violet
		PXP2513	4/0 1,5	90	12	Violet
3/8 Round Body, Taper Point	 	PXP2005	5/0 1,0	75	12	Violet
		PXP2520	4/0 1,5	75	12	Violet
3/8 Round Body, Taper Point	 	PXP2523	4/0 1,5	90	12	Violet
3/8 Reverse Cutting	 	PXP2021	5/0 1,0	75	12	Violet
19 mm						
3/8 Reverse Cutting	 	PXP2635	4/0 1,5	45	12	Violet
20 mm						
1/2 Round Body, Taper Point	 	PXP2685	4/0 1,5	75	12	Violet
		PXP3142	3/0 2,0	75	12	Violet
3/8 Reverse Cutting	 	PXP2719	4/0 1,5	75	12	Violet
22 mm						
1/2 Inside Cutting	 	PXP3217	3/0 2,0	45	12	Violet



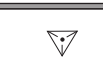

Antibacterial Polidiox Plus

Surgical Suture, Polydioxanone (PDO)
Absorbable, Synthetic, Monofilament, Violet

Needle Length and description	Product No	USP EP	Length (cm)	Unit Pcs	Color
25 mm					
1/2 Round Body, Taper Point  	PXP3252	3/0 2,0	75	12	Violet
	PXP3724	2/0 3,0	75	12	Violet
	PXP4190	0 3,5	75	12	Violet
26 mm					
1/2 Round Body, Taper Point  	PXP2828	4/0 1,5	75	12	Violet
	PXP3313	3/0 2,0	75	12	Violet
	PXP3786	2/0 3,0	75	12	Violet
3/8 Reverse Cutting  	PXP3346	3/0 2,0	75	12	Violet
3/8 Inside Cutting  	PXP3360	3/0 2,0	75	12	Violet
30 mm					
1/2 Round Body, Taper Point  	PXP3369	3/0 2,0	75	12	Violet
	PXP3858	2/0 3,0	75	12	Violet
	PXP4244	0 3,5	75	12	Violet
3/8 Reverse Cutting  	PXP3891	2/0 3,0	75	12	Violet
40 mm					
1/2 Round Body, Taper Point  	PXP3982	2/0 3,0	75	12	Violet
	PXP4368	0 3,5	75	12	Violet
	PXP4375	0 3,5	90	12	Violet
	PXP4713	1 4,0	75	12	Violet

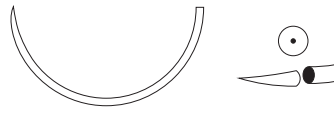
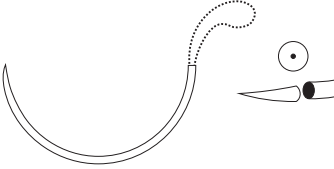
Antibacterial Polidiox Plus

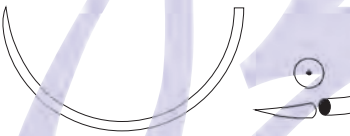
Surgical Suture, Polydioxanone (PDO)
Absorbable, Synthetic, Monofilament, Violet

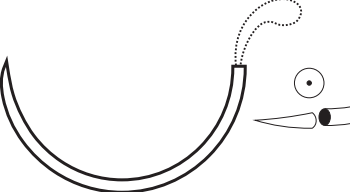
Needle Length and description	Product No	USP EP	Length (cm)	Unit Pcs	Color
40 mm					
1/2 Round Body, Taper Point 	PXP4719	1 4,0	90	12	Violet
	PXP5006	2 5,0	90	12	Violet
1/2 Round Body, Taper Point, LOOP 	PXP4388	0 3,5	150	12	Violet
	PXP4736	1 4,0	150	12	Violet
45 mm					
1/2 Round Body, Taper Point Heavy 	PXP4779	1 4,0	90	12	Violet
50 mm					
1/2 Round Body, Taper Point 	PXP4459	0 3,5	90	12	Violet
	PXP4818	1 4,0	90	12	Violet
	PXP5070	2 5,0	90	12	Violet
1/2 Round Body, Taper Point LOOP 	PXP4827	1 4,0	150	12	Violet
1/2 Round Body, Taper Point Heavy LOOP 	PXP4466	0 3,5	150	12	Violet



Boz Medical Device Industry and Trade Inc.

Absorbable Sutures

PLAIN CATGUT

CHROMIC CATGUT

Plain Catgut

Absorbable Surgical Suture



Boz[®]

Definition

Collagen based biomaterial, absorbable.

Material

Collagen tissue derived from purified sheep intestine

Coating

No coating

Structure

Monofilament

Colour

Yellowish

Size

EP : 1 to 8

USP : 6/0 to 4

Sterilization Method

Ethylene Oxide Gas











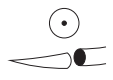

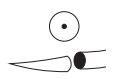

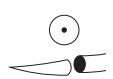

Gamma Irradiation

Main Indication

Ligatures

Ophthalmic Surgery









Plain Catgut Absorbable Surgical Suture

Needle Length and description	Product No	USP EP	Length (cm)	Unit Pcs	Color	
13 mm						
1/2 Round Body, Taper Point 330 Micron	 	CP1563	6/0 1,0	75	12	Yellowish
1/2 Round Body, Taper Point 430 Micron	 	CP1892	5/0 1,5	75	12	Yellowish
1/2 Round Body, Taper Point 330 Micron With Alcohol	 	CP1563A	6/0 1,0	75	12	Yellowish
3/8 Reverse Cutting 430 Micron	 	CP1933	5/0 1,5	75	12	Yellowish
3/8 Reverse Cutting 430 Micron With Alcohol	 	CP1933A	5/0 1,5	75	12	Yellowish
16 mm						
1/2 Round Body, Taper Point	 	CP1989	5/0 1,5	75	12	Yellowish
		CP2503	4/0 2,0	75	12	Yellowish
1/2 Round Body, Taper Point With Alcohol	 	CP1989A	5/0 1,5	75	12	Yellowish
		CP2503A	4/0 2,0	75	12	Yellowish
		CP3004A	3/0 3,0	75	12	Yellowish
3/8 Reverse Cutting	 	CP2019	5/0 1,5	75	12	Yellowish
		CP2539	4/0 2,0	75	12	Yellowish
		CP3024	3/0 3,0	75	12	Yellowish
3/8 Reverse Cutting With Alcohol	 	CP2019A	5/0 1,5	75	12	Yellowish
		CP2539A	4/0 2,0	75	12	Yellowish
		CP3024A	3/0 3,0	75	12	Yellowish

*All Catgut Sutures are available in conditioning fluid with isopropyl alcohol. "A" denotes the product is "wet" e.g.

*After code number CP####A





Plain Catgut Absorbable Surgical Suture

Needle Length and description	Product No	USP EP	Length (cm)	Unit Pcs	Color
20 mm					
1/2 Round Body, Taper Point 	CP2227	5/0 1,5	50	12	Yellowish
	CP2228	5/0 1,5	75	12	Yellowish
	CP2683	4/0 2,0	75	12	Yellowish
1/2 Round Body, Taper Point With Alcohol 	CP2683A	4/0 2,0	75	12	Yellowish
3/8 Reverse Cutting 	CP2718	4/0 2,0	75	12	Yellowish
	CP3167	3/0 3,0	75	12	Yellowish
3/8 Reverse Cutting With Alcohol 	CP2718A	4/0 2,0	75	12	Yellowish
25 mm					
1/2 Round Body, Taper Point With Alcohol 	CP2787A	4/0 2,0	75	12	Yellowish
3/8 Reverse Cutting 	CP2276	5/0 1,5	75	12	Yellowish
26 mm					
1/2 Round Body, Taper Point 	CP2827	4/0 2,0	75	12	Yellowish
1/2 Round Body, Taper Point With Alcohol 	CP2827A	4/0 2,0	75	12	Yellowish
	CP3312A	3/0 3,0	75	12	Yellowish
	CP3785A	2/0 3,5	75	12	Yellowish
3/8 Reverse Cutting 	CP2851	4/0 2,0	75	12	Yellowish
	CP3345	3/0 3,0	75	12	Yellowish
	CP3821	2/0 3,5	75	12	Yellowish

*All Catgut Sutures are available in conditioning fluid with isopropyl alcohol. "A" denotes the product is "wet" e.g.

*After code number CP####A







Plain Catgut Absorbable Surgical Suture

Needle Length and description	Product No	USP EP	Length (cm)	Unit Pcs	Color
26 mm					
3/8 Reverse Cutting With Alcohol 	CP3345A	3/0 3,0	75	12	Yellowish
	CP3821A	2/0 3,5	75	12	Yellowish
	CP4236A	0 4,0	75	12	Yellowish
30 mm					
1/2 Round Body, Taper Point 	CP3368	3/0 3,0	75	12	Yellowish
	CP4243	0 4,0	75	12	Yellowish
	CP4607	1 5,0	75	12	Yellowish
	CP4954	2 6,0	75	12	Yellowish
1/2 Round Body, Taper Point With Alcohol 	CP2874A	4/0 2,0	75	12	Yellowish
	CP3368A	3/0 3,0	75	12	Yellowish
	CP3857A	2/0 3,5	75	12	Yellowish
	CP4243A	0 4,0	75	12	Yellowish
	CP4607A	1 5,0	75	12	Yellowish
	CP3396	3/0 3,0	75	12	Yellowish
3/8 Reverse Cutting 	CP3890	2/0 3,5	75	12	Yellowish
	CP4272	0 4,0	75	12	Yellowish
	CP4628	1 5,0	75	12	Yellowish

*All Catgut Sutures are available in conditioning fluid with isopropyl alcohol. "A" denotes the product is "wet" e.g.

*After code number CP####A



Plain Catgut Absorbable Surgical Suture

Needle Length and description	Product No	USP EP	Length (cm)	Unit Pcs	Color
30 mm					
3/8 Reverse Cutting With Alcohol 	CP3396A	3/0 3,0	75	12	Yellowish
	CP3890A	2/0 3,5	75	12	Yellowish
	CP4272A	0 4,0	75	12	Yellowish
	CP4628A	1 5,0	75	12	Yellowish
35 mm					
1/2 Round Body, Taper Point 	CP3410	3/0 3,0	75	12	Yellowish
	CP3915	2/0 3,5	75	12	Yellowish
	CP4299	0 4,0	75	12	Yellowish
	CP4969	2 6,0	75	12	Yellowish
1/2 Round Body, Taper Point With Alcohol 	CP3410A	3/0 3,0	75	12	Yellowish
	CP4299A	0 4,0	75	12	Yellowish
	CP4643A	1 5,0	75	12	Yellowish
	CP4969A	2 6,0	75	12	Yellowish
1/2 Reverse Cutting 	CP4976	2 6,0	75	12	Yellowish
3/8 Reverse Cutting 	CP3422	3/0 3,0	75	12	Yellowish
	CP3932	2/0 3,5	75	12	Yellowish
	CP4319	0 4,0	75	12	Yellowish
3/8 Reverse Cutting With Alcohol 	CP3422A	3/0 3,0	75	12	Yellowish
	CP4319A	0 4,0	75	12	Yellowish

*All Catgut Sutures are available in conditioning fluid with isopropyl alcohol. "A" denotes the product is "wet" e.g.

*After code number CP####A

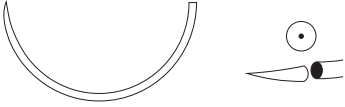
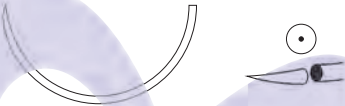

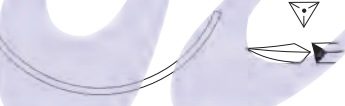
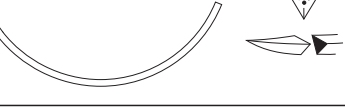
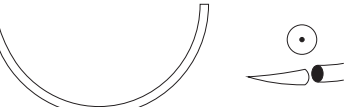
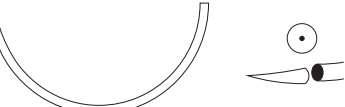





Plain Catgut Absorbable Surgical Suture

Needle Length and description	Product No	USP EP	Length (cm)	Unit Pcs	Color
40 mm					
1/2 Round Body, Taper Point 	CP4367	0 4,0	75	12	Yellowish
	CP4374	0 4,0	90	12	Yellowish
	CP4712	1 5,0	75	12	Yellowish
	CP5001	2 6,0	75	12	Yellowish
	CP5118	3 7,0	75	12	Yellowish
1/2 Round Body, Taper Point With Alcohol 	CP4367A	0 4,0	75	12	Yellowish
	CP4712A	1 5,0	75	12	Yellowish
	CP5001A	2 6,0	75	12	Yellowish
	CP5118A	3 7,0	75	12	Yellowish
1/2 Reverse Cutting With Alcohol 	CP5018A	2 6,0	75	12	Yellowish
3/8 Reverse Cutting 	CP4407	0 4,0	75	12	Yellowish
3/8 Reverse Cutting With Alcohol 	CP4407A	0 4,0	75	12	Yellowish
45 mm					
1/2 Round Body, Taper Point 	CP4421	0 4,0	75	12	Yellowish
	CP4771	1 5,0	75	12	Yellowish
	CP5034	2 6,0	75	12	Yellowish
1/2 Round Body, Taper Point With Alcohol 	CP4771A	1 5,0	75	12	Yellowish
	CP5034A	2 6,0	75	12	Yellowish

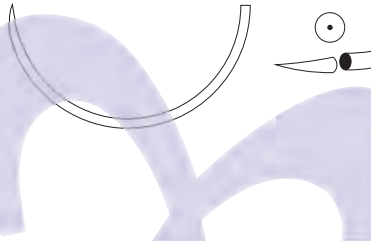
*All Catgut Sutures are available in conditioning fluid with isopropyl alcohol. "A" denotes the product is "wet" e.g.

*After code number CP####A

Plain Catgut Absorbable Surgical Suture

Needle Length and description	Product No	USP EP	Length (cm)	Unit Pcs	Color
45 mm					
3/8 Reverse Cutting 	CP4787	1 5,0	75	12	Yellowish
3/8 Reverse Cutting With Alcohol 	CP4787A	1 5,0	75	12	Yellowish
50 mm					
1/2 Round Body, Taper Point 	CP4453	0 4,0	75	12	Yellowish
	CP4811	1 5,0	75	12	Yellowish
	CP5065	2 6,0	75	12	Yellowish
	CP5127	3 7,0	75	12	Yellowish
1/2 Round Body, Taper Point With Alcohol 	CP4453A	0 4,0	75	12	Yellowish
	CP4811A	1 5,0	75	12	Yellowish
	CP5065A	2 6,0	75	12	Yellowish
	CP5127A	3 7,0	75	12	Yellowish
Straight Reverse Cutting 	CP3475	3/0 3,0	75	12	Yellowish
Straight Reverse Cutting With Alcohol 	CP3475A	3/0 3,0	75	12	Yellowish
60 mm					
Straight Reverse Cutting 	CP4073	2/0 3,5	75	12	Yellowish
Straight Reverse Cutting With Alcohol 	CP4073A	2/0 3,5	75	12	Yellowish

*All Catgut Sutures are available in conditioning fluid with isopropyl alcohol. "A" denotes the product is "wet" e.g.

*After code number CP####A

Plain Catgut

Absorbable Surgical Suture

Non-Needle Suture	Product No	USP EP	Length (cm)	Unit Pcs	Color
75 cm					
PLAIN CATGUT Non-Needle Suture	CP1748	5/0 1,5	75	12	Yellowish
	CP2316	4/0 2,0	75	12	Yellowish
	CP2925	3/0 3,0	75	12	Yellowish
	CP4104	0 4,0	75	12	Yellowish
	CP4521	1 5,0	75	12	Yellowish
	CP4898	2 6,0	75	12	Yellowish
75 cm With Alcohol					
PLAIN CATGUT Non-Needle Suture With Alcohol	CP1748A	5/0 1,5	75	12	Yellowish
	CP2316A	4/0 2,0	75	12	Yellowish
	CP2925A	3/0 3,0	75	12	Yellowish
	CP3530A	2/0 3,5	75	12	Yellowish
	CP4104A	0 4,0	75	12	Yellowish
	CP4898A	2 6,0	75	12	Yellowish
150 cm					
PLAIN CATGUT Non-Needle Suture	CP1736	5/0 1,5	150	12	Yellowish
	CP2325	4/0 2,0	150	12	Yellowish
	CP2934	3/0 3,0	150	12	Yellowish
	CP3510	2/0 3,5	150	12	Yellowish
	CP4113	0 4,0	150	12	Yellowish

*All Catgut Sutures are available in conditioning fluid with isopropyl alcohol. "A" denotes the product is "wet" e.g.

*After code number CP####A

Plain Catgut

Absorbable Surgical Suture

Non-Needle Suture	Product No	USP EP	Length (cm)	Unit Pcs	Color
150 cm					
PLAIN CATGUT Non-Needle Suture	CP4531	1 5,0	150	12	Yellowish
	CP4907	2 6,0	150	12	Yellowish
	CP5106	3 7,0	150	12	Yellowish
	CP5134	4 8,0	150	12	Yellowish

150 cm With Alcohol					
PLAIN CATGUT Non-Needle Suture With Alcohol	CP1736A	5/0 4,5	150	12	Yellowish
	CP2325A	4/0 2,0	150	12	Yellowish
	CP2934A	3/0 3,0	150	12	Yellowish
	CP3510A	2/0 3,5	150	12	Yellowish
	CP4113A	0 3,5	150	12	Yellowish
	CP4531A	1 4,0	150	12	Yellowish
	CP4907A	2 6,0	150	12	Yellowish
	CP5106A	3 7,0	150	12	Yellowish
	CP5134A	4 8,0	150	12	Yellowish

*All Catgut Sutures are available in conditioning fluid with isopropyl alcohol. "A" denotes the product is "wet" e.g.

*After code number CP####A

Chromic Catgut

Absorbable Surgical Suture

BOZ[®]



Definition

Collagen based biomaterial, absorbable.

Material

Collagen tissue derived from purified sheep intestine

Coating

No coating

Structure

Monofilament

Colour

Brown

Size

EP : 1 to 8

USP : 6/0 to 4

Sterilization Method

Ethylene Oxide Gas











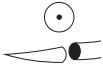

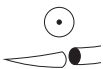

Gamma Irradiation

Main Indication

Ligatures

Ophthalmic Surgery











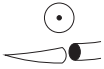

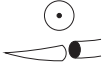
Chromic Catgut Absorbable Surgical Suture

Needle Length and description	Product No	USP EP	Length (cm)	Unit Pcs	Color	
13 mm						
1/2 Round Body, Taper Point 430 Micron With Alcohol	 	CK1892A	5/0 1,5	75	12	Brown
3/8 Reverse Cutting 430 Micron	 	CK1933	5/0 1,5	75	12	Brown
16 mm						
1/2 Round Body, Taper Point	 	CK1989	5/0 1,5	75	12	Brown
		CK2503	4/0 2,0	75	12	Brown
		CK3004	3/0 3,0	75	12	Brown
1/2 Round Body, Taper Point With Alcohol	 	CK1989A	5/0 1,5	75	12	Brown
		CK2503A	4/0 2,0	75	12	Brown
		CK3004A	3/0 3,0	75	12	Brown
3/8 Reverse Cutting	 	CK2019	5/0 1,5	75	12	Brown
		CK2539	4/0 2,0	75	12	Brown
		CK3024	3/0 3,0	75	12	Brown
3/8 Reverse Cutting With Alcohol	 	CK1670A	6/0 1,0	75	12	Brown
		CK2539A	4/0 2,0	75	12	Brown
		CK3024A	3/0 3,0	75	12	Brown
19 mm						
3/8 Reverse Cutting	 	CK2639	4/0 2,0	75	12	Brown
3/8 Reverse Cutting With Alcohol	 	CK2205A	5/0 1,5	75	12	Brown
		CK2639A	4/0 2,0	75	12	Brown

*All Catgut Sutures are available in conditioning fluid with isopropyl alcohol. "A" denotes the product is "wet" e.g.

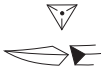
*After code number CK####A





Chromic Catgut Absorbable Surgical Suture

Needle Length and description	Product No	USP EP	Length (cm)	Unit Pcs	Color
20 mm					
1/2 Round Body, Taper Point  	CK2228	5/0 1,5	75	12	Brown
	CK2683	4/0 2,0	75	12	Brown
	CK3141	3/0 3,0	75	12	Brown
1/2 Round Body, Taper Point With Alcohol  	CK2683A	4/0 2,0	75	12	Brown
	CK3141A	3/0 3,0	75	12	Brown
3/8 Reverse Cutting  	CK2250	5/0 1,5	75	12	Brown
	CK2718	4/0 2,0	75	12	Brown
	CK3167	3/0 3,0	75	12	Brown
3/8 Reverse Cutting With Alcohol  	CK2250A	5/0 1,5	75	12	Brown
	CK2718A	4/0 2,0	75	12	Brown
	CK3167A	3/0 3,0	75	12	Brown
25 mm					
3/8 Reverse Cutting  	CK2800	4/0 2,0	75	12	Brown
3/8 Reverse Cutting With Alcohol  	CK2800A	4/0 2,0	75	12	Brown
26 mm					
1/2 Round Body, Taper Point  	CK2827	4/0 2,0	75	12	Brown
	CK3312	3/0 3,0	75	12	Brown
	CK3785	2/0 3,5	75	12	Brown

*All Catgut Sutures are available in conditioning fluid with isopropyl alcohol. "A" denotes the product is "wet" e.g.

*After code number CK####A





Chromic Catgut Absorbable Surgical Suture

Needle Length and description	Product No	USP EP	Length (cm)	Unit Pcs	Color
26 mm					
1/2 Round Body, Taper Point 	CK4214	0 4,0	75	12	Brown
	CK4589	1 5,0	75	12	Brown
	CK4946	2 6,0	75	12	Brown
1/2 Round Body, Taper Point With Alcohol 	CK2827A	4/0 2,0	75	12	Brown
	CK3312A	3/0 3,0	75	12	Brown
	CK3785A	2/0 3,5	75	12	Brown
	CK4214A	0 4,0	75	12	Brown
	CK4589A	1 5,0	75	12	Brown
3/8 Reverse Cutting 	CK2851	4/0 2,0	75	12	Brown
	CK3345	3/0 3,0	75	12	Brown
	CK3821	2/0 3,5	75	12	Brown
	CK4236	0 4,0	75	12	Brown
3/8 Reverse Cutting With Alcohol 	CK2851A	4/0 2,0	75	12	Brown
	CK3345A	3/0 3,0	75	12	Brown
	CK3821A	2/0 3,5	75	12	Brown
	CK4236A	0 4,0	75	12	Brown

*All Catgut Sutures are available in conditioning fluid with isopropyl alcohol. "A" denotes the product is "wet" e.g.

*After code number CK####A

Chromic Catgut Absorbable Surgical Suture

Needle Length and description	Product No	USP EP	Length (cm)	Unit Pcs	Color
30 mm					
1/2 Round Body, Taper Point 	CK3368	3/0 3,0	75	12	Brown
	CK3857	2/0 3,5	75	12	Brown
	CK4243	0 4,0	75	12	Brown
	CK4954	2 6,0	75	12	Brown
1/2 Round Body, Taper Point With Alcohol 	CK3857A	2/0 3,5	75	12	Brown
	CK4243A	0 4,0	75	12	Brown
	CK4607A	1 5,0	75	12	Brown
	CK4954A	2 6,0	75	12	Brown
3/8 Reverse Cutting 	CK3396	3/0 3,0	75	12	Brown
	CK3890	2/0 3,5	75	12	Brown
	CK4628	1 5,0	75	12	Brown
3/8 Reverse Cutting With Alcohol 	CK3396A	3/0 3,0	75	12	Brown
	CK3890A	2/0 3,5	75	12	Brown
	CK4272A	0 4,0	75	12	Brown
35 mm					
1/2 Round Body, Taper Point 	CK3410	3/0 3,0	75	12	Brown
	CK3915	2/0 3,5	75	12	Brown
	CK4299	0 4,0	75	12	Brown

*All Catgut Sutures are available in conditioning fluid with isopropyl alcohol. "A" denotes the product is "wet" e.g.

*After code number CK####A



Chromic Catgut Absorbable Surgical Suture





Needle Length and description	Product No	USP EP	Length (cm)	Unit Pcs	Color
35 mm					
1/2 Round Body, Taper Point 	CK4643	1 5,0	75	12	Brown
	CK4969	2 6,0	75	12	Brown
1/2 Round Body, Taper Point With Alcohol 	CK4299A	0 4,0	75	12	Brown
	CK4643A	1 5,0	75	12	Brown
1/2 Reverse Cutting 	CK4976	2 6,0	75	12	Brown
3/8 Reverse Cutting 	CK3422	3/0 3,0	75	12	Brown
	CK4319	0 4,0	75	12	Brown
3/8 Reverse Cutting With Alcohol 	CK4319A	0 4,0	75	12	Brown
40 mm					
1/2 Round Body, Taper Point 	CK4712	1 5,0	75	12	Brown
	CK5001	2 6,0	75	12	Brown
	CK5118	3 7,0	75	12	Brown
1/2 Round Body, Taper Point With Alcohol 	CK4367A	0 4,0	75	12	Brown
	CK5001A	2 6,0	75	12	Brown
	CK5118A	3 7,0	75	12	Brown
1/2 Reverse Cutting 	CK5018	2 6,0	75	12	Brown
	CK5120	3 7,0	75	12	Brown
1/2 Reverse Cutting With Alcohol 	CK5120A	3 7,0	75	12	Brown

*All Catgut Sutures are available in conditioning fluid with isopropyl alcohol. "A" denotes the product is "wet" e.g.

*After code number CK####A

Chromic Catgut Absorbable Surgical Suture

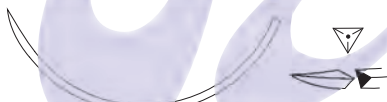
Needle Length and description	Product No	USP EP	Length (cm)	Unit Pcs	Color
40 mm					
3/8 Reverse Cutting 	CK4407	0 4,0	75	12	Brown
	CK4755	1 5,0	75	12	Brown
3/8 Reverse Cutting With Alcohol 	CK4407A	0 4,0	75	12	Brown
	CK4755A	1 5,0	75	12	Brown

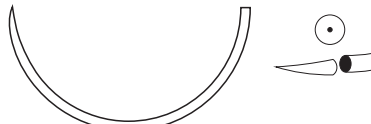

45 mm					
1/2 Round Body, Taper Point 	CK4421	0 4,0	75	12	Brown
	CK5034	2 6,0	75	12	Brown
1/2 Round Body, Taper Point With Alcohol 	CK4421A	0 4,0	75	12	Brown
	CK4771A	1 5,0	75	12	Brown
	CK5034A	2 6,0	75	12	Brown
3/8 Reverse Cutting With Alcohol 	CK4431A	0 4,0	75	12	Brown
Straight Reverse Cutting 	CK2911	4/0 2,0	75	12	Brown
Straight Reverse Cutting With Alcohol 	CK2911A	4/0 2,0	75	12	Brown

50 mm					
1/2 Round Body, Taper Point 	CK4811	1 5,0	75	12	Brown
	CK5065	2 6,0	75	12	Brown
	CK5127	3 7,0	75	12	Brown

*All Catgut Sutures are available in conditioning fluid with isopropyl alcohol. "A" denotes the product is "wet" e.g.

*After code number CK####A

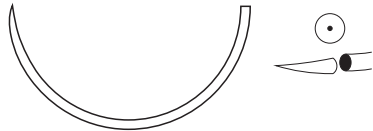
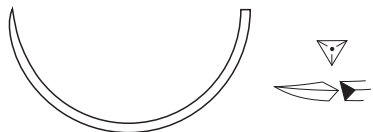
Chromic Catgut Absorbable Surgical Suture

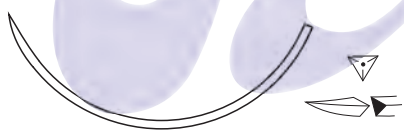
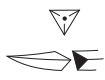
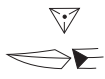
Needle Length and description	Product No	USP EP	Length (cm)	Unit Pcs	Color
50 mm					
1/2 Round Body, Taper Point With Alcohol 	CK4811A	1 5,0	75	12	Brown
	CK5065A	2 6,0	75	12	Brown
	CK5127A	3 7,0	75	12	Brown
1/2 Reverse Cutting 	CK5077	2 6,0	75	12	Brown
3/8 Reverse Cutting 	CK4474	0 4,0	75	12	Brown
	CK4840	1 5,0	75	12	Brown
	CK5082	2 6,0	75	12	Brown
	CK5130	3 7,0	75	12	Brown
3/8 Reverse Cutting With Alcohol 	CK4840A	1 5,0	75	12	Brown
	CK5082A	2 6,0	75	12	Brown
	CK5130A	3 7,0	75	12	Brown
60 mm					
Straight Reverse Cutting 	CK3491	3/0 3,0	75	12	Brown
	CK4073	2/0 3,5	75	12	Brown
Straight Reverse Cutting With Alcohol 	CK4073A	2/0 3,5	75	12	Brown

*All Catgut Sutures are available in conditioning fluid with isopropyl alcohol. "A" denotes the product is "wet" e.g.

*After code number CK####A

Chromic Catgut Absorbable Surgical Suture

Non-Needle Suture	Product No	USP EP	Length (cm)	Unit Pcs	Color
150 cm					
CHROMIC CATGUT Non-Needle Suture	CK1373	6/0 1,0	150	12	Brown
	CK1736	5/0 1,5	150	12	Brown
	CK2325	4/0 2,0	150	12	Brown
	CK2934	3/0 3,0	150	12	Brown
	CK3510	2/0 3,5	150	12	Brown
	CK4113	0 4,0	150	12	Brown
	CK4531	1 5,0	150	12	Brown
	CK4907	2 6,0	150	12	Brown
	CK5106	3 7,0	150	12	Brown
	CK5134	4 8,0	150	12	Brown

150 cm With Alcohol					
CHROMIC CATGUT Non-Needle Suture With Alcohol	CK1373A	6/0 1,0	150	12	Brown
	CK1736A	5/0 1,5	150	12	Brown
	CK2325A	4/0 2,0	150	12	Brown
	CK2934A	3/0 3,0	150	12	Brown
	CK3510A	2/0 3,5	150	12	Brown
	CK4113A	0 4,0	150	12	Brown
	CK4531A	1 5,0	150	12	Brown

*All Catgut Sutures are available in conditioning fluid with isopropyl alcohol. "A" denotes the product is "wet" e.g.

*After code number CK####A

Chromic Catgut Absorbable Surgical Suture

Non-Needle Suture	Product No	USP EP	Length (cm)	Unit Pcs	Color
150 cm With Alcohol					
CHROMIC CATGUT Non-Needle Suture With Alcohol	CK4907A	2 6,0	150	12	Brown
	CK5106A	3 7,0	150	12	Brown
	CK5134A	4 8,0	150	12	Brown

75 cm					
CHROMIC CATGUT Non-Needle Suture	CK1748	5/0 1,5	75	12	Brown
	CK2316	4/0 2,0	75	12	Brown
	CK2925	3/0 3,0	75	12	Brown
	CK3530	2/0 3,5	75	12	Brown
	CK4104	0 4,0	75	12	Brown
	CK4521	1 5,0	75	12	Brown
	CK4898	2 6,0	75	12	Brown

75 cm With Alcohol					
CHROMIC CATGUT Non-Needle Suture With Alcohol	CK1748A	5/0 1,5	75	12	Brown
	CK2316A	4/0 2,0	75	12	Brown
	CK2925A	3/0 3,0	75	12	Brown
	CK3530A	2/0 3,5	75	12	Brown
	CK4104A	0 4,0	75	12	Brown
	CK4521A	1 5,0	75	12	Brown
	CK4898A	2 6,0	75	12	Brown

*All Catgut Sutures are available in conditioning fluid with isopropyl alcohol. "A" denotes the product is "wet" e.g.

*After code number CK####A



Boz Medical Device Industry and Trade Inc.

Non - Absorbable Sutures

SILK

MONOPROLEN

MONOFLORID

MONAMID

MULTAMID

POLISIL

MONOTEF

POLYTEF

MONOWIRE

TEMPOWIRE

web : www.boztibbi.com
email: boz@boztibbi.com

Surgical Sutures Non-Absorbable

Silk

Surgical Suture, Silk, Silicone Coated
Nonabsorbable, Noncapillary

Boz®



Definition

Natural Non-absorbable

Material

Natural Silk

Coating

Silicon Coated, Paraffin Wax, Uncoated

Structure

Braided, Twisted

Colour

Black, Ivory, methylene blue

Size

EP : 0.2 to 7

USP : 10/0 to 5

Tensile Strength Retention

Moderate Loss

Mass Absorption

Permanent

Sterilization Method

Ethylene Oxide Gas

Main Indication

Ligatures
Skin Closure
Oral Surgery
Neurosurgery
Cardiovascular procedures
Ophthalmic procedures











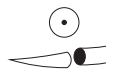

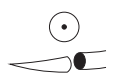

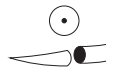

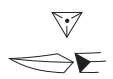
Silk

Surgical Suture, Silk, Silicone Coated Nonabsorbable, Noncapillary

Needle Length and description			Product No	USP EP	Length (cm)	Unit Pcs	Color
6 mm							
3/8 Spatula 200 Micron			SB1120	9/0 0,3	30	12	Black
3/8 Spatula 220 Micron			SB1153	8/0 0,4	45	12	Black
6,55 mm							
3/8 Spatula 220 Micron			SB1174	8/0 0,4	45	12	Black
7,6 mm							
1/2 Reverse Cutting 330 Micron			SB5522	6/0 0,7	75	12	Black
8 mm							
1/2 Spatula 230 Micron			SB1197	8/0 0,4	45	12	Black
1/4 Spatula 330 Micron			SB1399	6/0 0,7	45	12	Black
			SB1761	5/0 1,0	45	12	Black
3/8 Round Body, Taper Point 230 Micron			SB1297	7/0 0,5	45	12	Black
3/8 Round Body, Taper Point 230 Micron			SB1209	8/0 0,4	45	12	Black
3/8 Reverse Cutting 280 Micron			SB1308	7/0 0,5	45	12	Black
3/8 Spatula 230 Micron			SB1201	8/0 0,4	45	12	Black
			SB1282	7/0 0,5	45	12	Black
3/8 Spatula 280 Micron			SB1414	6/0 0,7	45	12	Black
10 mm							
3/8 Round Body, Taper Point 330 Micron			SB1810	5/0 1,0	75	12	Black
3/8 Reverse Cutting 330 Micron			SB1495	6/0 0,7	45	12	Black

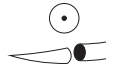

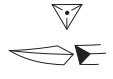







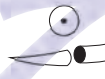

Silk

Surgical Suture, Silk, Silicone Coated Nonabsorbable, Noncapillary

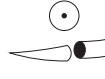
Needle Length and description	Product No	USP EP	Length (cm)	Unit Pcs	Color
13 mm					
3/8 Round Body, Taper Point 330 Micron  	SB1581	6/0 0,7	45	12	Black
	SB1591	6/0 0,7	75	12	Black
3/8 Round Body, Taper Point 380 Micron  	SB1913	5/0 1,0	75	12	Black
3/8 Round Body, Taper Point 430 Micron  	SB2437	4/0 1,5	75	12	Black
3/8 Reverse Cutting 330 Micron  	SB1613	6/0 0,7	45	12	Black
3/8 Reverse Cutting 330 Micron  	SB1617	6/0 0,7	45	12	Black
3/8 Reverse Cutting 430 Micron  	SB1931	5/0 1,0	45	12	Black
	SB2446	4/0 1,5	45	12	Black
16 mm					
1/2 Round Body, Taper Point  	SB1653	6/0 0,7	45	12	Black
	SB1993	5/0 1,0	75	12	Black
	SB2505	4/0 1,5	75	12	Black
	SB3006	3/0 2,0	75	12	Black
1/2 Reverse Cutting  	SB3019	3/0 2,0	75	12	Black
3/8 Reverse Cutting  	SB1667	6/0 0,7	45	12	Black
	SB1671	6/0 0,7	75	12	Black
	SB2015	5/0 1,0	45	12	Black

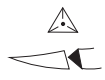

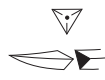

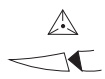

Silk

Surgical Suture, Silk, Silicone Coated Nonabsorbable, Noncapillary

Needle Length and description	Product No	USP EP	Length (cm)	Unit Pcs	Color
16 mm					
3/8 Reverse Cutting  	SB2023	5/0 1,0	75	12	Black
	SB2542	4/0 1,5	75	12	Black
3/8 Inside Cutting  	SB1683	6/0 0,7	75	12	Black
	SB2145	5/0 1,0	75	12	Ivory
	SB2146	5/0 1,0	75	12	Black
	SB2558	4/0 1,5	75	12	Black
	SB3041	3/0 2,0	75	12	Black
18 mm					
1/2 Round Body, Taper Point  	SB2176	5/0 1,0	75	12	Black
	SB2614	4/0 1,5	75	12	Black
	SB3082	3/0 2,0	75	12	Black
3/8 Round Body, Taper Point  	SB4164	0 3,5	75	12	Black
3/8 Inside Cutting  	SB2192	5/0 1,0	75	12	Black
	SB3094	3/0 2,0	75	12	Black
19 mm					
3/8 Reverse Cutting  	SB5418	5/0 1,0	75	12	Black
	SB2641	4/0 1,5	75	12	Black
3/8 Inside Cutting  	SB2662	4/0 1,5	75	12	Black





Silk

Surgical Suture, Silk, Silicone Coated Nonabsorbable, Noncapillary

Needle Length and description	Product No	USP EP	Length (cm)	Unit Pcs	Color
20 mm					
1/2 Round Body, Taper Point 	SB2231	5/0 1,0	75	12	Black
	SB2687	4/0 1,5	75	12	Black
	SB3145	3/0 2,0	75	12	Black
	SB3649	2/0 3,0	75	12	Black
1/2 Reverse Cutting 	SB2711	4/0 1,5	75	12	Black
	SB3163	3/0 2,0	75	12	Black
1/2 Inside Cutting 	SB2725	4/0 1,5	75	12	Black
3/8 Reverse Cutting 	SB2251	5/0 1,0	75	12	Black
	SB2720	4/0 1,5	75	12	Black
	SB3171	3/0 2,0	75	12	Black
	SB3664	2/0 3,0	75	12	Black
3/8 Inside Cutting 	SB2257	5/0 1,0	75	12	Black
	SB2732	4/0 1,5	75	12	Black
	SB3183	3/0 2,0	75	12	Black
22 mm					
1/2 Round Body, Taper Point 	SB2749	4/0 1,5	75	12	Black
1/2 Inside Cutting 	SB3221	3/0 2,0	75	12	Black
	SB3687	2/0 3,0	75	12	Black





Silk

Surgical Suture, Silk, Silicone Coated Nonabsorbable, Noncapillary

Needle Length and description	Product No	USP EP	Length (cm)	Unit Pcs	Color
25 mm					
3/8 Reverse Cutting 	SB2807	4/0 1,5	75	12	Black
	SB2279	5/0 1,0	45	12	Black
3/8 Inside Cutting 	SB2282	5/0 1,0	75	12	Black
	SB2813	4/0 1,5	45	12	Black
	SB3286	3/0 2,0	75	12	Black
	SB3764	2/0 3,0	75	12	Black
26 mm					
1/2 Round Body, Taper Point 	SB2831	4/0 1,5	75	12	Black
	SB3315	3/0 2,0	75	12	Black
	SB3789	2/0 3,0	75	12	Black
	SB4218	0 3,5	75	12	Black
1/2 Reverse Cutting 	SB3337	3/0 2,0	75	12	Black
	SB4231	0 3,5	75	12	Black
3/8 Reverse Cutting 	SB2854	4/0 1,5	75	12	Black
	SB3347	3/0 2,0	75	12	Black
	SB3825	2/0 3,0	75	12	Black
	SB4238	0 3,5	75	12	Black

Silk

Surgical Suture, Silk, Silicone Coated Nonabsorbable, Noncapillary

Needle Length and description	Product No	USP EP	Length (cm)	Unit Pcs	Color
30 mm					
1/2 Round Body, Taper Point 	SB3371	3/0 2,0	75	12	Black
	SB3859	2/0 3,0	75	12	Black
	SB4245	0 3,5	75	12	Black
	SB4609	1 4,0	75	12	Black
1/2 Reverse Cutting 	SB3883	2/0 3,0	75	12	Black
	SB4267	0 3,5	75	12	Black
	SB4624	1 4,0	75	12	Black
3/8 Reverse Cutting 	SB2886	4/0 1,5	75	12	Black
	SB3399	3/0 2,0	75	12	Black
30 mm					
3/8 Reverse Cutting 	SB3893	2/0 3,0	75	12	Black
	SB4274	0 3,5	75	12	Black
	SB4630	1 4,0	75	12	Black
35 mm					
1/2 Round Body, Taper Point 	SB3917	2/0 3,0	75	12	Black
	SB4301	0 3,5	75	12	Black
	SB4646	1 4,0	75	12	Black



Silk

Surgical Suture, Silk, Silicone Coated Nonabsorbable, Noncapillary

Needle Length and description	Product No	USP EP	Length (cm)	Unit Pcs	Color
35 mm					
3/8 Reverse Cutting 	SB3425	3/0 2,0	75	12	Black
	SB3934	2/0 3,0	75	12	Black
	SB4663	1 4,0	75	12	Black
37 mm					
1/2 Round Body, Taper Point 	SB4339	0 3,5	75	12	Black
	SB4683	1 4,0	75	12	Black
1/2 Reverse Cutting 	SB4353	0 3,5	75	12	Black
	SB4695	1 4,0	75	12	Black
40 mm					
1/2 Round Body, Taper Point 	SB3983	2/0 3,0	75	12	Black
	SB4370	0 3,5	75	12	Black
	SB4716	1 4,0	75	12	Black
	SB5004	2 5,0	75	12	Black
1/2 Reverse Cutting 	SB4746	1 4,0	75	12	Black
	SB5020	2 5,0	75	12	Black
3/8 Reverse Cutting 	SB4409	0 3,5	75	12	Black
	SB4757	1 4,0	75	12	Black
	SB4759	1 4,0	90	12	Black

Silk

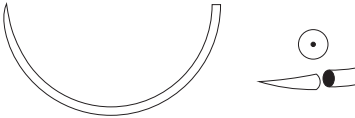
Surgical Suture, Silk, Silicone Coated Nonabsorbable, Noncapillary

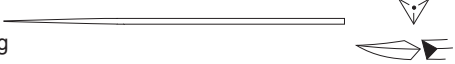
Needle Length and description	Product No	USP EP	Length (cm)	Unit Pcs	Color
45 mm					
1/2 Round Body, Taper Point 	SB5037	2 5,0	75	12	Black
3/8 Reverse Cutting 	SB4788	1 4,0	75	12	Black
Straight Reverse Cutting 	SB3463	3/0 2,0	75	12	Black

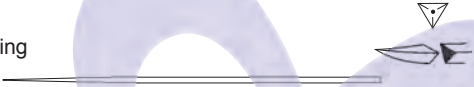
50 mm					
Straight Reverse Cutting 	SB4048	2/0 3,0	75	12	Black

60 mm					
Straight Reverse Cutting 	SB3493	3/0 2,0	75	12	Black
	SB4076	2/0 3,0	75	12	Black

Silk

Surgical Suture, Silk, Silicone Coated Nonabsorbable, Noncapillary

Non-Needle Suture	Product No	USP EP	Length (cm)	Unit Pcs	Color
10x75 cm					
<p>SILK Non-Needle Suture</p>	SB2340	4/0 1,5	10x75	12	Black
	SB2956	3/0 2,0	10x75	12	Black
	SB3549	2/0 3,0	10x75	12	Black
	SB4142	0 3,5	10x75	12	Black
	SB4552	1 4,0	10x75	12	Black
	SB4929	2 5,0	10x75	12	Black

12x45 cm					
<p>SILK Non-Needle Suture</p>	SB5840	0 3,5	12x45	12	Black
	SB5839	1 4,0	12x45	12	Black

13x60 cm					
<p>SILK Non-Needle Suture</p>	SB2348	4/0 1,5	13x60	12	Black
	SB2963	3/0 2,0	13x60	12	Black
	SB3555	2/0 3,0	13x60	12	Black
	SB4148	0 3,5	13x60	12	Black
	SB4558	1 4,0	13x60	12	Black

Silk

Surgical Suture, Silk, Silicone Coated Nonabsorbable, Noncapillary

Non-Needle Suture	Product No	USP EP	Length (cm)	Unit Pcs	Color
17x45 cm					
<p>SILK Non-Needle Suture</p>	SB1740	5/0 1,0	17x45	12	Black
	SB2351	4/0 1,5	17x45	12	Black
	SB2964	3/0 2,0	17x45	12	Black
	SB3560	2/0 3,0	17x45	12	Black
	SB4151	0 3,5	17x45	12	Black
	SB4938	2 5,0	17x45	12	Black
	SB4561	1 4,0	17x45	12	Black
150 cm					
<p>SILK Non-Needle Suture</p>	SB2936	3/0 2,0	150	12	Black
180 cm					
<p>SILK Non-Needle Suture</p>	SB2940	3/0 2,0	180	12	Black
	SB3516	2/0 3,0	180	12	Black
	SB4119	0 3,5	180	12	Black
	SB4539	1 4,0	180	12	Black
	SB4914	2 5,0	180	12	Black
	SB5107	3 6,0	180	12	Black
	SB5133	4 6,0	180	12	Black

Monoprolen

Surgical Suture, Polypropylene (PP)
Nonabsorbable, Synthetic, Monofilament

Boz[®]

Definition

Synthetic Non-Absorbable

Material

Polypropylene (PP)

Coating

No Coating

Structure

Monofilament

Colour

Blue, Black, Undyed

Size

EP : 0.2 to 5

USP : 10/0 to 2

Tensile Strenght Retention

Permanent

Mass Absorption

Permanent

Sterilization Method

Ethylene Oxide Gas

Main Indication

Microsugery

Skin closure

Cosmetic Surgery

Cardiac Surgery

Vascular Surgery











Ophthalmic procedures

Neurosurgical procedures

Monoprolen Surgical Suture, Polypropylene (PP) Nonabsorbable, Synthetic, Monofilament

Needle Length and description	Product No	USP EP	Length (cm)	Unit Pcs	Color
5 mm					
3/8 Round Body, Taper Point 130 Micron	ML1047	10/0 0,2	13	12	Black
5.1 mm					
3/8 Round Body, Taper Point 100 Micron	ML1110	9/0 0,3	13	12	Blue
6 mm					
3/8 Round Body, Taper Point 130 Micron	ML1161	8/0 0,4	60	12	Blue
3/8 Round Body, Taper Point 220 Micron	ML1255	7/0 0,5	75	12	Blue
3/8 Round Body, Taper Point 150 Micron	ML1387	6/0 0,7	45	12	Blue
6.5 mm					
3/8 Spatula 130 Micron	ML1172	8/0 0,4	45	12	Blue
8 mm					
3/8 Round Body, Taper Point 220 Micron	ML1292	7/0 0,5	60	12	Blue
3/8 Round Body, Taper Point 220 Micron Black Needle	ML1422	6/0 0,7	60	12	Blue
3/8 Round Body, Taper Point 220 Micron Black Needle	ML1293	7/0 0,5	60	12	Blue
3/8 Round Body, Taper Point 230 Micron	ML1212	8/0 0,4	60	12	Blue
	ML1213	8/0 0,4	75	12	Blue
3/8 Round Body, Taper Point 230 Micron Black Needle	ML1211	8/0 0,4	60	12	Blue
3/8 Round Body, Taper Point 280 Micron	ML1300	7/0 0,5	45	12	Blue
	ML1305	7/0 0,5	60	12	Blue











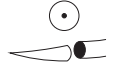

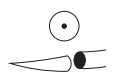

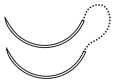

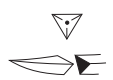
Monoprolen Surgical Suture, Polypropylene (PP) Nonabsorbable, Synthetic, Monofilament

Needle Length and description		Product No	USP EP	Length (cm)	Unit Pcs	Color
8 mm						
3/8 Round Body, Taper Point 280 Micron		ML1425	6/0 0,7	45	12	Blue
		ML1430	6/0 0,7	60	12	Blue
3/8 Spatula 220 Micron		ML1284	7/0 0,5	75	12	Blue
9 mm						
3/8 Round Body, Taper Point 230 Micron		ML1313	7/0 0,5	75	12	Blue
10 mm						
1/2 Round Body, Taper Point 280 Micron		ML1463	6/0 0,7	75	12	Blue
3/8 Round Body, Taper Point 220 Micron		ML1326	7/0 0,5	60	12	Blue
3/8 Round Body, Taper Point 230 Micron Black Needle		ML1324	7/0 0,5	75	12	Blue
3/8 Round Body, Taper Point 280 Micron		ML1477	6/0 0,7	60	12	Blue
		ML1483	6/0 0,7	75	12	Blue
3/8 Round Body, Taper Point 280 Micron Black Needle		ML1476	6/0 0,7	60	12	Blue
3/8 Round Body, Taper Point 330 Micron		ML1801	5/0 1,0	60	12	Blue
		ML1802	5/0 1,0	75	12	Blue
3/8 Reverse Cutting 340 Micron		ML1497	6/0 0,7	45	12	Blue
12 mm						
3/8 Round Body, Taper Point 280 Micron		ML1346	7/0 0,5	75	12	Blue







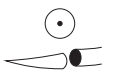

Monoprolen Surgical Suture, Polypropylene (PP) Nonabsorbable, Synthetic, Monofilament

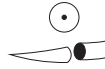
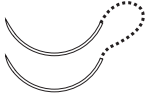
Needle Length and description	Product No	USP EP	Length (cm)	Unit Pcs	Color	
13 mm						
1/2 Round Body, Taper Point 320 Micron	 	ML1882	5/0 1,0	75	12	Blue
1/2 Round Body, Taper Point 330 Micron	 	ML1565	6/0 0,7	75	12	Blue
1/2 Round Body, Taper Point 330 Micron	 	ML1566	6/0 0,7	75	12	Blue
		ML1569	6/0 0,7	90	12	Blue
1/2 Round Body, Taper Point 380 Micron	 	ML1884	5/0 1,0	75	12	Blue
1/2 Round Body, Taper Point 430 Micron	 	ML2427	4/0 1,5	75	12	Blue
1/2 Round Body, Taper Point 430 Micron	 	ML1898	5/0 1,0	75	12	Blue
		ML2428	4/0 1,5	75	12	Blue
3/8 Round Body, Taper Point 230 Micron	 	ML1363	7/0 0,5	60	12	Blue
3/8 Round Body, Taper Point 280 Micron	 	ML1571	6/0 0,7	60	12	Blue
3/8 Round Body, Taper Point 280 Micron Black Needle	 	ML1365	7/0 0,5	75	12	Blue
		ML1572	6/0 0,7	60	12	Blue
3/8 Round Body, Taper Point 330 Micron	 	ML1582	6/0 0,7	45	12	Blue
		ML1592	6/0 0,7	75	12	Blue
3/8 Round Body, Taper Point 330 Micron	 	ML1584	6/0 0,7	60	12	Blue
		ML1588	6/0 0,7	75	12	Blue
3/8 Round Body, Taper Point 330 Micron Black Needle	 	ML1593	6/0 0,7	90	12	Blue







Monoprolen Surgical Suture, Polypropylene (PP) Nonabsorbable, Synthetic, Monofilament

Needle Length and description	Product No	USP EP	Length (cm)	Unit Pcs	Color		
13 mm							
3/8 Round Body, Taper Point 380 Micron			ML1910	5/0 1,0	60	12	Blue
3/8 Round Body, Taper Point 380 Micron			ML1917	5/0 1,0	75	12	Blue
3/8 Reverse Cutting 330 Micron			ML1612	6/0 0,7	45	12	Blue
3/8 Reverse Cutting 330 Micron			ML1621	6/0 0,7	75	12	Blue
3/8 Reverse Cutting 380 Micron			ML1927	5/0 1,0	45	12	Blue
3/8 Reverse Cutting 560 Micron			ML2454	4/0 1,5	45	12	Blue
3/8 Spatula 280 Micron			ML1606	6/0 0,7	75	12	Blue
16 mm							
1/2 Round Body, Taper Point			ML1987	5/0 1,0	45	12	Blue
			ML2506	4/0 1,5	75	12	Blue
			ML3007	3/0 2,0	75	12	Blue
1/2 Round Body, Taper Point			ML1658	6/0 0,7	90	12	Blue
			ML1998	5/0 1,0	90	12	Blue
			ML2514	4/0 1,5	90	12	Blue
			ML3010	3/0 2,0	90	12	Blue
1/2 Round Body, Taper Point Black Needle			ML1997	5/0 1,0	90	12	Blue
			ML2499	4/0 1,5	45	12	Blue





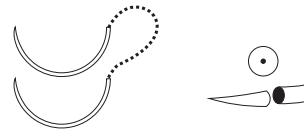



Monoprolen Surgical Suture, Polypropylene (PP) Nonabsorbable, Synthetic, Monofilament

Needle Length and description			Product No	USP EP	Length (cm)	Unit Pcs	Color
16 mm							
3/8 Round Body, Taper Point			ML2007	5/0 1,0	75	12	Blue
			ML2009	5/0 1,0	90	12	Blue
3/8 Round Body, Taper Point			ML2524	4/0 1,5	90	12	Blue
			ML1669	6/0 0,7	45	12	Blue
3/8 Reverse Cutting			ML1672	6/0 0,7	75	12	Blue
			ML2017	5/0 1,0	45	12	Blue
			ML2126	5/0 1,0	90	12	Blue
			ML2536	4/0 1,5	45	12	Blue
			ML2541	4/0 1,5	75	12	Blue
			ML3027	3/0 2,0	75	12	Blue
			ML1681	6/0 0,7	45	12	Blue
3/8 Inside Cutting			ML2141	5/0 1,0	45	12	Blue
			ML2556	4/0 1,5	45	12	Blue
			ML3041	3/0 2,0	75	12	Blue
			ML1690	6/0 0,7	75	12	Blue
17 mm							
1/2 Round Body, Taper Point			ML2164	5/0 1,0	75	12	Blue
			ML3060	3/0 2,0	75	12	Blue

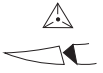

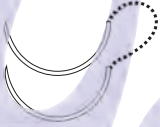
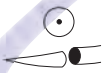

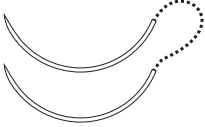
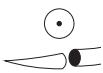

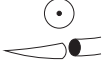
Monoprolen Surgical Suture, Polypropylene (PP) Nonabsorbable, Synthetic, Monofilament

Needle Length and description	Product No	USP EP	Length (cm)	Unit Pcs	Color
17 mm					
3/8 Round Body, Taper Point 	ML2169	5/0 1,0	90	12	Blue
	ML2595	4/0 1,5	90	12	Blue
18 mm					
1/2 Round Body, Taper Point 	ML2615	4/0 1,5	75	12	Blue
19 mm					
3/8 Reverse Cutting 	ML2207	5/0 1,0	75	12	Blue
	ML2642	4/0 1,5	75	12	Blue
20 mm					
1/2 Round Body, Taper Point 	ML2230	5/0 1,0	75	12	Blue
	ML2684	4/0 1,5	75	12	Blue
	ML3143	3/0 2,0	75	12	Blue
	ML3647	2/0 3,0	75	12	Blue
1/2 Round Body, Taper Point 	ML2234	5/0 1,0	90	12	Blue
	ML2696	4/0 1,5	90	12	Blue
	ML3155	3/0 2,0	90	12	Blue
1/2 Round Body, Taper Point Black Needle 	ML2697	4/0 1,5	90	12	Blue
3/8 Reverse Cutting 	ML2249	5/0 1,0	45	12	Blue
	ML2715	4/0 1,5	45	12	Blue

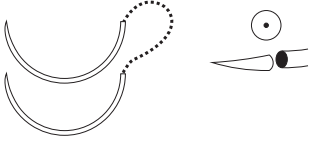

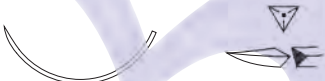

Monoprolen Surgical Suture, Polypropylene (PP) Nonabsorbable, Synthetic, Monofilament

Needle Length and description	Product No	USP EP	Length (cm)	Unit Pcs	Color
20 mm					
3/8 Reverse Cutting  	ML2721	4/0 1,5	75	12	Blue
	ML3166	3/0 2,0	45	12	Blue
	ML3169	3/0 2,0	75	12	Blue
3/8 Inside Cutting  	ML2253	5/0 1,0	45	12	Blue
	ML2726	4/0 1,5	45	12	Blue
	ML3178	3/0 2,0	45	12	Blue
	ML3182	3/0 2,0	75	12	Blue
22 mm					
1/2 Round Body, Taper Point  	ML2267	5/0 1,0	75	12	Blue
1/2 Round Body, Taper Point  	ML2753	4/0 1,5	90	12	Blue
1/2 Inside Cutting  	ML3218	3/0 2,0	45	12	Blue
3/8 Round Body, Taper Point  	ML2270	5/0 1,0	90	12	Blue
	ML2758	4/0 1,5	90	12	Blue
25 mm					
1/2 Round Body, Taper Point  	ML2785	4/0 1,5	45	12	Blue
	ML3253	3/0 2,0	75	12	Blue
	ML3725	2/0 3,0	75	12	Blue
	ML4194	0 3,5	100	12	Blue



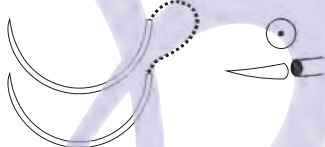

Monoprolen Surgical Suture, Polypropylene (PP) Nonabsorbable, Synthetic, Monofilament

Needle Length and description	Product No	USP EP	Length (cm)	Unit Pcs	Color
25 mm					
1/2 Round Body, Taper Point 	ML2796	4/0 1,5	90	12	Blue
	ML3261	3/0 2,0	90	12	Blue
	ML3735	2/0 3,0	75	12	Blue
	ML3744	2/0 3,0	90	12	Blue
1/2 Round Body, Taper Point Black Needle 	ML2795	4/0 1,5	90	12	Blue
	ML3260	3/0 2,0	90	12	Blue
3/8 Reverse Cutting 	ML2806	4/0 1,5	75	12	Blue
	ML3272	3/0 2,0	45	12	Blue
3/8 Inside Cutting 	ML2811	4/0 1,5	45	12	Blue
	ML3283	3/0 2,0	45	12	Blue
	ML3761	2/0 3,0	45	12	Blue
26 mm					
1/2 Round Body, Taper Point 	ML2830	4/0 1,5	75	12	Blue
	ML3787	2/0 3,0	75	12	Blue
	ML4216	0 3,5	75	12	Blue
	ML4591	1 4,0	75	12	Blue
3/8 Reverse Cutting 	ML2853	4/0 1,5	75	12	Blue
	ML3348	3/0 2,0	75	12	Blue
	ML3823	2/0 3,0	75	12	Blue



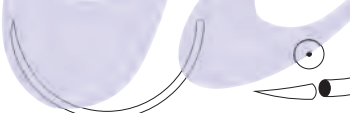
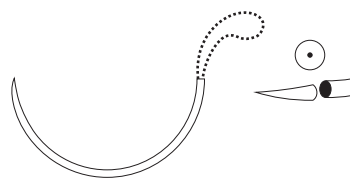

Monoprolen Surgical Suture, Polypropylene (PP) Nonabsorbable, Synthetic, Monofilament

Needle Length and description	Product No	USP EP	Length (cm)	Unit Pcs	Color
30 mm					
1/2 Round Body, Taper Point 	ML2875	4/0 1,5	75	12	Blue
	ML3372	3/0 2,0	75	12	Blue
	ML3861	2/0 3,0	75	12	Blue
	ML4246	0 3,5	75	12	Blue
	ML4615	1 4,0	100	12	Blue
	ML4610	1 4,0	75	12	Blue
1/2 Round Body, Taper Point 	ML3378	3/0 2,0	90	12	Blue
	ML3867	2/0 3,0	90	12	Blue
1/2 Reverse Cutting 	ML3390	3/0 2,0	75	12	Blue
	ML3884	2/0 3,0	75	12	Blue
3/8 Reverse Cutting 	ML3398	3/0 2,0	75	12	Blue
	ML3894	2/0 3,0	75	12	Blue
	ML4276	0 3,5	75	12	Blue
	ML4631	1 4,0	75	12	Blue
35 mm					
1/2 Round Body, Taper Point 	ML3413	3/0 2,0	75	12	Blue
	ML3919	2/0 3,0	75	12	Blue

Monoprolen Surgical Suture, Polypropylene (PP) Nonabsorbable, Synthetic, Monofilament

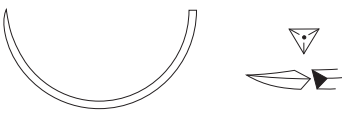
Needle Length and description	Product No	USP EP	Length (cm)	Unit Pcs	Color
35 mm					
1/2 Round Body, Taper Point 	ML4302	0 3,5	75	12	Blue
	ML4652	1 4,0	100	12	Blue
3/8 Reverse Cutting 	ML3426	3/0 2,0	75	12	Blue
	ML3936	2/0 3,0	75	12	Blue
	ML4321	0 3,5	75	12	Blue
	ML4662	1 4,0	75	12	Blue
40 mm					
1/2 Round Body, Taper Point 	ML3990	2/0 3,0	100	12	Blue
	ML4377	0 3,5	100	12	Blue
	ML4371	0 3,5	75	12	Blue
	ML4726	1 4,0	100	12	Blue
	ML4715	1 4,0	75	12	Blue
	ML5011	2 5,0	100	12	Blue
	ML5002	2 5,0	75	12	Blue
1/2 Round Body, Taper Point LOOP 	ML4387	0 3,5	150	12	Blue
	ML4737	1 4,0	150	12	Blue
1/2 Round Body, Taper Point Heavy 	ML4733	1 4,0	100	12	Blue

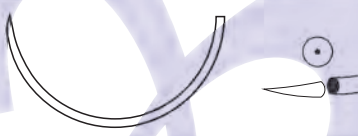
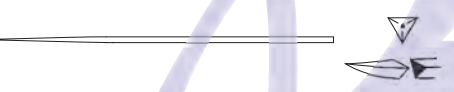
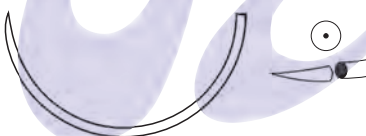
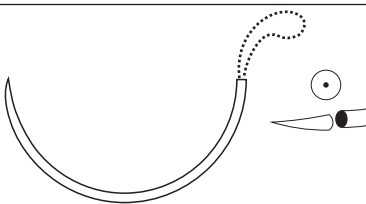
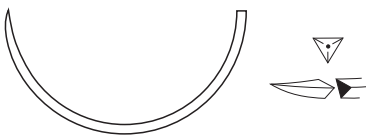
Monoprolen Surgical Suture, Polypropylene (PP) Nonabsorbable, Synthetic, Monofilament

Needle Length and description	Product No	USP EP	Length (cm)	Unit Pcs	Color
40 mm					
1/2 Reverse Cutting 	ML4402	0 3,5	100	12	Blue
	ML4751	1 4,0	100	12	Blue
3/8 Reverse Cutting 	ML4009	2/0 3,0	100	12	Blue
	ML4413	0 3,5	100	12	Blue
	ML4760	1 4,0	100	12	Blue
45 mm					
1/2 Round Body, Taper Point LOOP 	ML4781	1 4,0	150	12	Blue
Straight Reverse Cutting 	ML4028	2/0 3,0	75	12	Blue
50 mm					
1/2 Round Body, Taper Point 	ML4820	1 4,0	100	12	Blue
	ML5071	2 5,0	100	12	Blue
1/2 Round Body, Taper Point LOOP 	ML4465	0 3,5	150	12	Blue
	ML4829	1 4,0	150	12	Blue
1/2 Reverse Cutting 	ML4837	1 4,0	100	12	Blue
60 mm					
Straight Reverse Cutting 	ML3495	3/0 2,0	75	12	Blue
	ML4077	2/0 3,0	75	12	Blue

Monoprolen Surgical Suture, Polypropylene (PP) Nonabsorbable, Synthetic, Monofilament

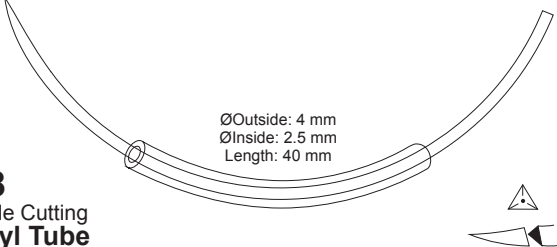
Needle Length and description	Product No	USP EP	Length (cm)	Unit Pcs	Color
90 mm					
 <p>3/8 Inside Cutting Vinyl Tube</p> <p>ØOutside: 4 mm ØInside: 2.5 mm Length: 40 mm</p>	ML4887	1 4,0	2 X 50	12	Blue

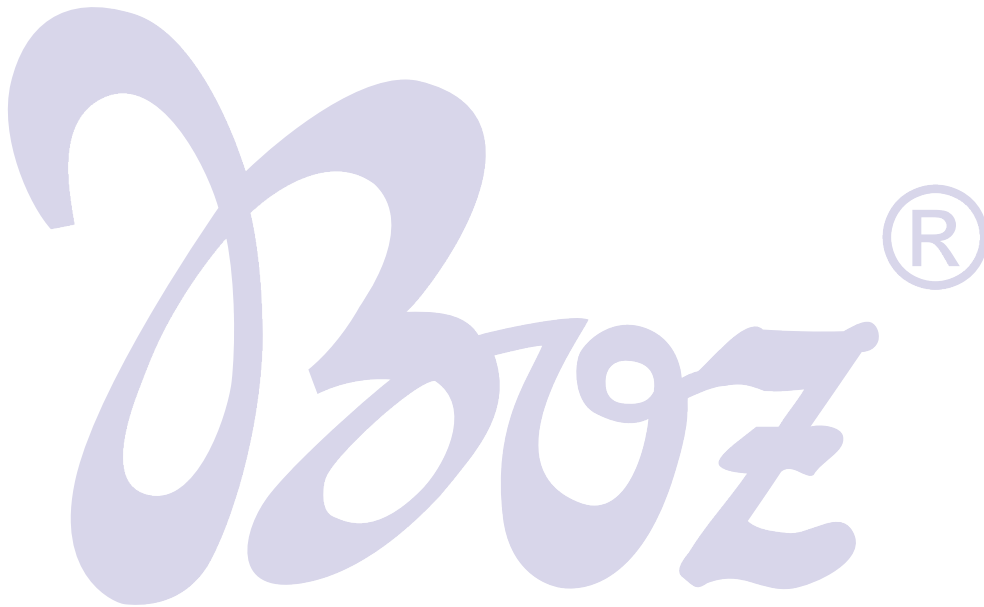

Monoflorid

Surgical Suture, Poly(vinylidene difluoride) (PVDF)
Nonabsorbable, Synthetic, Monofilament

BOZ[®]



Definition

Synthetic Non-Absorbable

Material

Polyvinylidene difluoride (PVDF)

Coating

No Coating

Structure

Monofilament

Colour

Blue, Black

Size

EP : 0.2 to 5

USP : 10/0 to 2

Tensile Strenght Retention

Permanent

Mass Absorption

Permanent

Sterilization Method

Ethylene Oxide Gas

Main Indication

Cosmetic Surgery

Skin closure











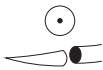

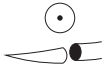









Cardiovascular procedures

Ophthalmic procedures

Neurosurgical procedures

Monoflorid

Surgical Suture, Poly(vinylidene difluoride) (PVDF)
Nonabsorbable, Synthetic, Monofilament

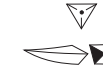
Needle Length and description			Product No	USP EP	Length (cm)	Unit Pcs	Color
9 mm							
3/8 Round Body, Taper Point 230 Micron Black Needle			MD1311	7/0 0,5	60	12	Blue
10 mm							
3/8 Round Body, Taper Point 220 Micron			MD1325	7/0 0,5	45	12	Blue
13 mm							
1/2 Round Body, Taper Point 330 Micron			MD1565	6/0 0,7	75	12	Blue
1/2 Round Body, Taper Point 330 Micron			MD1566	6/0 0,7	75	12	Blue
3/8 Round Body, Taper Point 280 Micron			MD1363	7/0 0,5	60	12	Blue
3/8 Round Body, Taper Point 330 Micron Black Needle			MD1583	6/0 0,7	45	12	Blue
3/8 Round Body, Taper Point 330 Micron Black Needle			MD1589	6/0 0,7	75	12	Blue
3/8 Round Body, Taper Point 330 Micron			MD1584	6/0 0,7	60	12	Blue
			MD1588	6/0 0,7	75	12	Blue
3/8 Round Body, Taper Point 380 Micron Black Needle			MD1907	5/0 1,0	45	12	Blue
3/8 Round Body, Taper Point 380 Micron			MD1912	5/0 1,0	60	12	Blue
			MD1917	5/0 1,0	75	12	Blue
16 mm							
1/2 Round Body, Taper Point			MD1654	6/0 0,7	60	12	Blue
3/8 Reverse Cutting			MD1669	6/0 0,7	45	12	Blue
			MD2017	5/0 1,0	45	12	Blue
			MD2536	4/0 1,5	45	12	Blue















Monoflorid

Surgical Suture, Poly(vinylidene difluoride) (PVDF)
Nonabsorbable, Synthetic, Monofilament

Needle Length and description				Product No	USP EP	Length (cm)	Unit Pcs	Color
16 mm								
3/8 Reverse Cutting			MD2541	4/0 1,5	75	12	Blue	
			MD3023	3/0 2,0	45	12	Blue	
3/8 Inside Cutting			MD2141	5/0 1,0	45	12	Blue	
			MD2556	4/0 1,5	45	12	Blue	
17 mm								
1/2 Round Body, Taper Point			MD2164	5/0 1,0	75	12	Blue	
			MD2585	4/0 1,5	75	12	Blue	
3/8 Round Body, Taper Point			MD2169	5/0 1,0	90	12	Blue	
18 mm								
1/2 Round Body, Taper Point			MD2180	5/0 1,0	90	12	Blue	
			MD2616	4/0 1,5	90	12	Blue	
20 mm								
1/2 Round Body, Taper Point			MD2230	5/0 1,0	75	12	Blue	
			MD2684	4/0 1,5	75	12	Blue	
			MD3143	3/0 2,0	75	12	Blue	
			MD3647	2/0 3,0	75	12	Blue	
1/2 Round Body, Taper Point			MD2234	5/0 1,0	90	12	Blue	
			MD2696	4/0 1,5	90	12	Blue	
			MD3149	3/0 2,0	90	12	Blue	

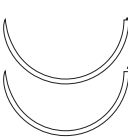









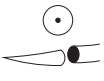

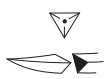
Monoflorid

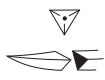
Surgical Suture, Poly(vinylidene difluoride) (PVDF)
Nonabsorbable, Synthetic, Monofilament

Needle Length and description			Product No	USP EP	Length (cm)	Unit Pcs	Color
20 mm							
3/8 Reverse Cutting			MD2715	4/0 1,5	45	12	Blue
			MD3169	3/0 2,0	75	12	Blue
3/8 Inside Cutting			MD2726	4/0 1,5	45	12	Blue
			MD3182	3/0 2,0	75	12	Blue
25 mm							
1/2 Round Body, Taper Point			MD3253	3/0 2,0	75	12	Blue
			MD3725	2/0 3,0	75	12	Blue
3/8 Reverse Cutting			MD3275	3/0 2,0	75	12	Blue
			MD3758	2/0 3,0	75	12	Blue
26 mm							
1/2 Round Body, Taper Point			MD2830	4/0 1,5	75	12	Blue
			MD3320	3/0 2,0	90	12	Blue
1/2 Round Body, Taper Point			MD2836	4/0 1,5	90	12	Blue
			MD3323	3/0 2,0	90	12	Blue
			MD3796	2/0 3,0	90	12	Blue
1/2 Reverse Cutting			MD2300	5/0 1,0	75	12	Blue
30 mm							
1/2 Round Body, Taper Point			MD3372	3/0 2,0	75	12	Blue
			MD3861	2/0 3,0	75	12	Blue

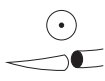
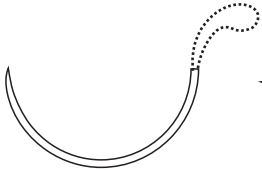
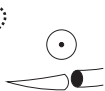

Monoflorid

Surgical Suture, Poly(vinylidene difluoride) (PVDF)
Nonabsorbable, Synthetic, Monofilament

Needle Length and description	Product No	USP EP	Length (cm)	Unit Pcs	Color
30 mm					
1/2 Round Body, Taper Point  	MD4246	0 3,5	75	12	Blue
	MD4610	1 4,0	75	12	Blue
1/2 Reverse Cutting  	MD3884	2/0 3,0	75	12	Blue
3/8 Reverse Cutting  	MD3398	3/0 2,0	75	12	Blue
	MD3894	2/0 3,0	75	12	Blue
	MD4276	0 3,5	75	12	Blue
	MD4276	0 3,5	75	12	Blue
35 mm					
1/2 Round Body, Taper Point  	MD4302	0 3,5	75	12	Blue
3/8 Reverse Cutting  	MD4321	0 3,5	75	12	Blue
40 mm					
1/2 Round Body, Taper Point  	MD4377	0 3,5	100	12	Blue
	MD4371	0 3,5	75	12	Blue
	MD4726	1 4,0	100	12	Blue
	MD4715	1 4,0	75	12	Blue
1/2 Round Body, Taper Point, LOOP  	MD4387	0 3,5	150	12	Blue
	MD4737	1 4,0	150	12	Blue
1/2 Reverse Cutting  	MD4402	0 3,5	100	12	Blue
	MD4751	1 4,0	100	12	Blue

Monoflorid

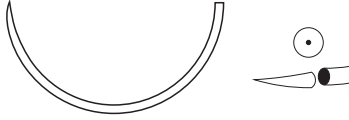
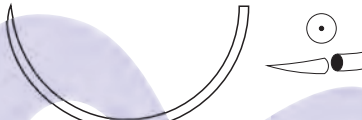
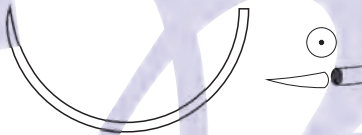
Surgical Suture, Poly(vinylidene difluoride) (PVDF)
Nonabsorbable, Synthetic, Monofilament

Needle Length and description	Product No	USP EP	Length (cm)	Unit Pcs	Color
40 mm					
3/8 Reverse Cutting 	MD4006	2/0 3,0	75	12	Blue
45 mm					
1/2 Round Body, Taper Point, LOOP 	MD4427	0 3,5	150	12	Blue
50 mm					
1/2 Round Body, Taper Point 	MD4813	1 4,0	75	12	Blue
1/2 Round Body, Taper Point, LOOP 	MD4465	0 3,5	150	12	Blue
	MD4829	1 4,0	150	12	Blue
60 mm					
Straight Reverse Cutting 	MD3495	3/0 2,0	75	12	Blue

Monamid

Surgical Suture, Monofilament Polyamide (PA)
Nonabsorbable, Synthetic

BOZ[®]

BOZ[®]

Definition

Synthetic Non-Absorbable

Material

Nylon 6 and Nylon 6.6 (PA)

Coating

Uncoated

Structure

Monofilament

Colour

Blue, Black, Undyed

Size

EP : 0.2 to 5

USP : 10/0 to 2

Tensile Strenght Retention

Moderate Loss

Mass Absorption

Permanent

Sterilization Method

Ethylene Oxide Gas

Main Indication

General Soft tissue approximation or ligation

Cardiovascular

Ophthalmic Surgery

Neurosurgical Surgery

Plastic Surgery

Monamid Surgical Suture, Monofilament Polyamide (PA) Nonabsorbable, Synthetic

Needle Length and description	Product No	USP EP	Length (cm)	Unit Pcs	Color
4 mm					
3/8 Round Body, Taper Point 70 Micron	MA1001	11/0 0,1	10	12	Black
3/8 Round Body, Taper Point 100 Micron	MA1023	10/0 0,2	15	12	Black
3/8 Round Body, Taper Point 150 Micron	MA1099	9/0 0,3	30	12	Black
	MA1129	8/0 0,4	13	12	Black
5 mm					
3/8 Round Body, Taper Point 100 Micron	MA1045	10/0 0,2	13	12	Black
	MA1107	9/0 0,3	13	12	Black
3/8 Round Body, Taper Point 130 Micron	MA1133	8/0 0,4	13	12	Black
6 mm					
3/8 Round Body, Taper Point 140 Micron	MA1162	8/0 0,4	15	12	Black
3/8 Spatula 150 Micron Micropoint	MA1065	10/0 0,2	30	12	Black
3/8 Spatula 150 Micron	MA1066	10/0 0,2	30	12	Black
	MA1068	10/0 0,2	45	12	Black
	MA1118	9/0 0,3	30	12	Black
6,6 mm					
1/2 Cobra 150 Micron	MA5520	10/0 0,2	60	12	Blue
	MA5521	9/0 0,3	60	12	Blue
10 mm					
1/2 Reverse Cutting 330 Micron	MA1488	6/0 0,7	45	12	Black
3/8 Reverse Cutting 330 Micron	MA1495	6/0 0,7	45	12	Black





Monamid Surgical Suture, Monofilament Polyamide (PA) Nonabsorbable, Synthetic

Needle Length and description	Product No	USP EP	Length (cm)	Unit Pcs	Color
13 mm					
3/8 Reverse Cutting 330 Micron 	MA1612	6/0 0,7	45	12	Blue
	MA1619	6/0 0,7	75	12	Blue
16 mm					
1/2 Reverse Cutting 3/8 Reverse Cutting 	MA2012	5/0 1,0	75	12	Blue
	MA1672	6/0 0,7	75	12	Blue
	MA1667	6/0 0,7	45	12	Black
	MA2017	5/0 1,0	45	12	Blue
	MA2536	4/0 1,5	45	12	Blue
	MA2542	4/0 1,5	75	12	Black
	MA3021	3/0 2,0	45	12	Black
	MA3027	3/0 2,0	75	12	Blue
19 mm					
3/8 Reverse Cutting 	MA2201	5/0 1,0	45	12	Blue
	MA2207	5/0 1,0	75	12	Blue
	MA2638	4/0 1,5	45	12	Blue
	MA2642	4/0 1,5	75	12	Blue
3/8 Inside Cutting 	MA3120	3/0 2,0	45	12	Blue
	MA3121	3/0 2,0	45	12	Black

Monamid Surgical Suture, Monofilament Polyamide (PA) Nonabsorbable, Synthetic

Needle Length and description	Product No	USP EP	Length (cm)	Unit Pcs	Color
19 mm					
3/8 Inside Cutting 	MA3125	3/0 2,0	75	12	Blue
	MA2659	4/0 1,5	45	12	Blue
	MA2663	4/0 1,5	75	12	Blue
20 mm					
1/2 Reverse Cutting 	MA3162	3/0 2,0	75	12	Blue
3/8 Reverse Cutting 	MA3165	3/0 2,0	45	12	Black
24 mm					
3/8 Inside Cutting 	MA3235	3/0 2,0	45	12	Blue
25 mm					
1/2 Tapercutting 	MA5513	3/0 2,0	45	12	Blue
3/8 Reverse Cutting 	MA2802	4/0 1,5	45	12	Blue
	MA3758	2/0 3,0	75	12	Blue
3/8 Inside Cutting 	MA2811	4/0 1,5	45	12	Blue
26 mm					
1/2 Reverse Cutting 	MA3812	2/0 3,0	75	12	Blue
3/8 Reverse Cutting 	MA3344	3/0 2,0	45	12	Blue
	MA3347	3/0 2,0	75	12	Black
	MA3348	3/0 2,0	75	12	Blue

Monamid Surgical Suture, Monofilament Polyamide (PA) Nonabsorbable, Synthetic

Needle Length and description	Product No	USP EP	Length (cm)	Unit Pcs	Color
26 mm					
3/8 Reverse Cutting 	MA3820	2/0 3,0	45	12	Blue
	MA3823	2/0 3,0	75	12	Blue
3/8 Inside Cutting 	MA3358	3/0 2,0	45	12	Blue
30 mm					
1/2 Round Body, Taper Point 	MA4254	0 3,5	100	12	Blue
	MA4255	0 3,5	100	12	Black
	MA4615	1 4,0	100	12	Blue
	MA4610	1 4,0	75	12	Blue
1/2 Reverse Cutting 	MA3392	3/0 2,0	90	12	Blue
	MA3884	2/0 3,0	75	12	Blue
3/8 Reverse Cutting 	MA3398	3/0 2,0	75	12	Blue
	MA3399	3/0 2,0	75	12	Black
	MA3893	2/0 3,0	75	12	Black
	MA3894	2/0 3,0	75	12	Blue
	MA4276	0 3,5	75	12	Blue
	MA4631	1 4,0	75	12	Blue
3/8 Inside Cutting 	MA3902	2/0 3,0	75	12	Blue

Monamid Surgical Suture, Monofilament Polyamide (PA) Nonabsorbable, Synthetic

Needle Length and description	Product No	USP EP	Length (cm)	Unit Pcs	Color
35 mm					
1/2 Round Body, Taper Point 	MA4309	0 3,5	100	12	Black
	MA4298	0 3,5	45	12	Blue
	MA4652	1 4,0	100	12	Black
1/2 Reverse Cutting 	MA4317	0 3,5	75	12	Black
3/8 Reverse Cutting 	MA3936	2/0 3,0	75	12	Blue
	MA4664	1 4,0	100	12	Blue
38 mm					
1/2 Reverse Cutting 	MA5512	2/0 3,0	75	12	Black
	MA5510	0 3,5	75	12	Black
40 mm					
1/2 Round Body, Taper Point 	MA4377	0 3,5	100	12	Blue
	MA4370	0 3,5	75	12	Black
	MA4725	1 4,0	100	12	Black
	MA4726	1 4,0	100	12	Blue
1/2 Round Body, Taper Point LOOP 	MA4387	0 3,5	150	12	Blue
1/2 Reverse Cutting 	MA4401	0 3,5	100	12	Black
	MA4402	0 3,5	100	12	Blue

Monamid Surgical Suture, Monofilament Polyamide (PA) Nonabsorbable, Synthetic

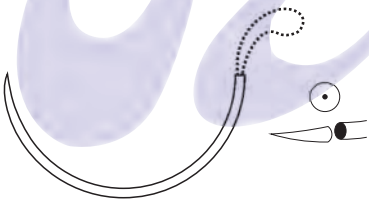
Needle Length and description	Product No	USP EP	Length (cm)	Unit Pcs	Color
40 mm					
1/2 Reverse Cutting Heavy 	MA4405	0 3,5	100	12	Black
3/8 Reverse Cutting 	MA4758	1 4,0	75	12	Blue
45 mm					
1/2 Round Body, Taper Point LOOP 	MA4781	1 4,0	150	12	Blue
3/8 Reverse Cutting 	MA4789	1 4,0	75	12	Blue
50 mm					
1/2 Round Body, Taper Point LOOP 	MA4464	0 3,5	150	12	Black
	MA4465	0 3,5	150	12	Blue
	MA4828	1 4,0	150	12	Black
	MA4829	1 4,0	150	12	Blue
60 mm					
Straight Reverse Cutting 	MA4077	2/0 3,0	75	12	Blue
61 mm					
Straight Reverse Cutting 	MA4083	2/0 3,0	100	12	Blue

Surgical Sutures Non-Absorbable

Multamid

Surgical Suture, Multifilament Polyamide (PA) Silicone Coated
Nonabsorbable, Synthetic, Black



Boz®



®

Definition

Synthetic Non-Absorbable

Material

Nylon 6 and Nylon 6.6 (PA)

Coating

Silicone, Paraffin Wax Uncoated

Structure

Braided

Colour

Black, Blue, Undyed

Size

EP : 0.01 to 7

USP : 12/0 to 5

Tensile Strenght Retention

Moderate Loss

Mass Absorption

Permanent

Sterilization Method





Ethylene Oxide Gas

Main Indication

General Soft tissue
approximation or ligation
Cardiovascular
Ophthalmic Surgery
Neurosurgical Surgery
Plastic Surgery

Multamid

Surgical Suture, Multifilament Polyamide (PA)
Silicone Coated Nonabsorbable, Synthetic

Needle Length and description		Product No	USP EP	Length (cm)	Unit Pcs	Color	
16 mm							
1/2 Round Body, Taper Point  	MU3006	3/0 2,0	75	12	Black		
	26 mm						
1/2 Round Body, Taper Point  	MU2824	4/0 1,5	8 X 45	6	Black		
	MU3315	3/0 2,0	75	12	Black		
	MU3789	2/0 3,0	75	12	Black		
	MU3792	2/0 3,0	8 X 75	6	Black		
	MU4218	0 3,5	75	12	Black		
	MU4590	1 4,0	75	12	Black		
3/8 Reverse Cutting  	MU3343	3/0 2,0	45	12	Black		
	MU4238	0 3,5	75	12	Black		
30 mm							
1/2 Round Body, Taper Point  	MU3371	3/0 2,0	75	12	Black		
	MU3859	2/0 3,0	75	12	Black		
	MU4609	1 4,0	75	12	Black		
35 mm							
1/2 Round Body, Taper Point  	MU4301	0 3,5	75	12	Black		
	3/8 Reverse Cutting  	MU3425	3/0 2,0	75	12	Black	
MU3934		2/0 3,0	75	12	Black		
MU4663		1 4,0	75	12	Black		

Multamid

Surgical Suture, Multifilament Polyamide (PA)
Silicone Coated Nonabsorbable, Synthetic

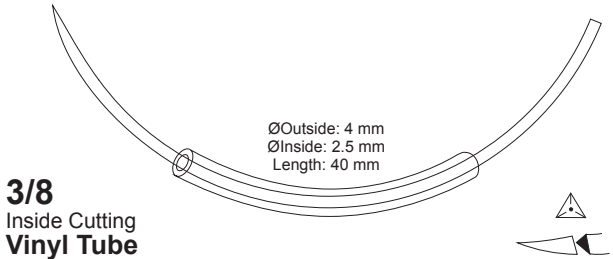
Needle Length and description	Product No	USP EP	Length (cm)	Unit Pcs	Color
90 mm					
 <p>3/8 Inside Cutting Vinyl Tube</p>	MU4886	1 4,0	2 X 50	12	Black

Non-Needle Suture	Product No	USP EP	Length (cm)	Unit	Color
17x45 cm					
MULTAMID Non-Needle Suture	MU1740	5/0 1,0	17x45	12	Black
	MU2351	4/0 1,5	17x45	12	Black
	MU2964	3/0 2,0	17x45	12	Black
	MU3560	2/0 3,0	17x45	12	Black
	MU4561	1 4,0	17x45	12	Black

10x75 cm					
MULTAMID Non-Needle Suture	MU2340	4/0 1,5	10x75	12	Black
	MU2956	3/0 2,0	10x75	12	Black
	MU3549	2/0 3,0	10x75	12	Black
	MU4552	1 4,0	10x75	12	Black

Surgical Sutures Non-Absorbable

Polisil

Surgical Suture, Braided Polyester, Silicone Coated (PET)
Nonabsorbable, Synthetic



Boz®

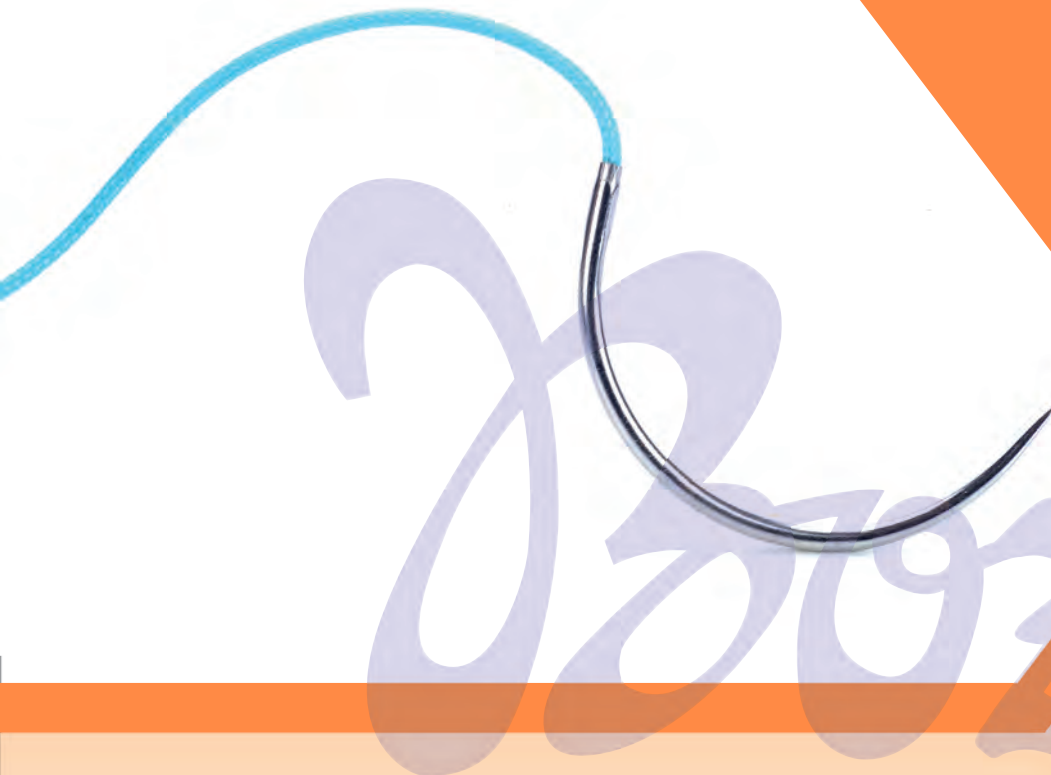

Definition

Synthetic Non- Absorbable

Material

Polyester Polyethylene Terephthalate (PET)

Coating

Silicone, Uncoated

Structure

Braided

Colour

Green, White

Size

EP : 0.5 to 7
USP : 7/0 to 5

Tensile Strenght Retention

Permanent

Mass Absorption

Permanent

Sterilization Method

Ethylene Oxide Gas

Main Indication

Cardiac Valve Repair
General Surgery
Cardiovascular Procedures
Neurosurgical Procedures

Polisil

Surgical Suture, Braided Polyester, Silicone Coated (PET) Nonabsorbable, Synthetic

Needle Length and description	Product No	USP EP	Length (cm)	Unit Pcs	Color		
8 mm							
1/2 Spatula 340 Micron			PS1756	5/0 1,0	45	12	Green
1/4 Spatula 340 Micron			PS1408	6/0 0,7	45	12	Green
			PS1765	5/0 1,0	45	12	White
			PS1766	5/0 1,0	45	12	Green
3/8 Round Body, Taper Point 280 Micron			PS1302	7/0 0,5	45	12	Green
8,1 mm							
1/4 Sabre 380 Micron			PS5531	4/0 1,5	60	12	Green
10 mm							
3/8 Round Body, Taper Point 280 Micron			PS1482	6/0 0,7	75	12	Green
3/8 Spatula 280 Micron			PS1452	6/0 0,7	45	12	Green
13 mm							
3/8 Round Body, Taper Point 280 Micron			PS1573	6/0 0,7	75	12	Green
3/8 Round Body, Taper Point 320 Micron			PS1903	5/0 1,0	75	12	Green
3/8 Round Body, Taper Point 330 Micron			PS1587	6/0 0,7	75	12	Green
3/8 Round Body, Taper Point 330 Micron 6mm x 3mm x 3mm Teflon Pledget		 	PS1916	5/0 1,0	75	12	Green
3/8 Reverse Cutting 560 Micron			PS2455	4/0 1,5	45	12	White
3/8 Spatula 280 Micron			PS1604	6/0 0,7	45	12	Green

Polisil

Surgical Suture, Braided Polyester, Silicone Coated (PET) Nonabsorbable, Synthetic

Needle Length and description	Product No	USP EP	Length (cm)	Unit Pcs	Color	
16 mm						
1/2 Round Body, Taper Point		PS3008	3/0 2,0	75	12	Green
1/2 Round Body, Taper Point		PS2515	4/0 1,5	90	12	Green
		PS3011	3/0 2,0	90	12	Green
1/2 Round Body, Taper Point		PS3012	3/0 2,0	90	6	5 Green 5 White
		PS5923	3/0 2,0	90	12	Green
6mm x 3mm x 1.5mm Teflon Pledget						
3/8 Inside Cutting		PS2560	4/0 1,5	75	12	Green
		PS3040	3/0 2,0	75	12	Green
17 mm						
1/2 Round Body, Taper Point		PS2582	4/0 1,5	75	12	Green
		PS3609	2/0 3,0	75	12	Green
1/2 Round Body, Taper Point		PS2587	4/0 1,5	90	12	Green
		PS3066	3/0 2,0	90	12	Green
		PS3613	2/0 3,0	90	12	Green
		PS3615	2/0 3,0	90	6	5 Green 5 White
1/2 Round Body, Taper Point		PS2579	4/0 1,5	75	12	Green
		PS3606	2/0 3,0	75	6	5 Green 5 White
		PS3617	2/0 3,0	90	12	Green
3mm x 3mm x 1.5mm Teflon Pledget						



Polisil

Surgical Suture, Braided Polyester, Silicone Coated (PET) Nonabsorbable, Synthetic

Needle Length and description	Product No	USP EP	Length (cm)	Unit Pcs	Color
17 mm					
1/2 Round Body, Taper Point 6mm x 3mm x 1.5mm Teflon Pledget   	PS3067	3/0 2,0	90	6	5 Green 5 White
	PS3616	2/0 3,0	90	6	5 Green 5 White
	PS3618	2/0 3,0	90	12	Green
1/2 Tapercutting  	PS2570	4/0 1,5	90	12	Green
1/2 Tapercutting 7mm x 3mm x 1.5mm Teflon Pledget   	PS3592	2/0 3,0	75	6	5 Green 5 White
3/8 Round Body, Taper Point  	PS5762	3/0 2,0	75	12	Green
20 mm					
1/2 Round Body, Taper Point  	PS3648	2/0 3,0	75	12	Green
1/2 Round Body, Taper Point  	PS3650	2/0 3,0	75	12	Green
1/2 Round Body, Taper Point  	PS2688	4/0 1,5	75	12	Green
	PS2695	4/0 1,5	90	12	Green
	PS5843	3/0 2,0	75	12	Green
	PS3148	3/0 2,0	90	12	Green
1/2 Round Body, Taper Point 6mm x 3mm x 1.5mm Teflon Pledget   	PS3651	2/0 3,0	75	6	5 Green 5 White
	PS3653	2/0 3,0	90	12	Green
1/2 Round Body, Taper Point 6mm x 3mm x 3mm Teflon Pledget   	PS2706	4/0 1,5	75	12	Green



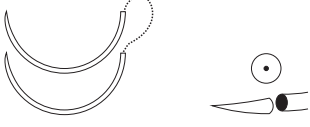
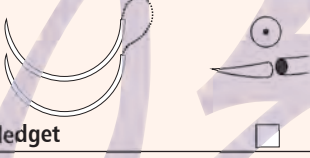
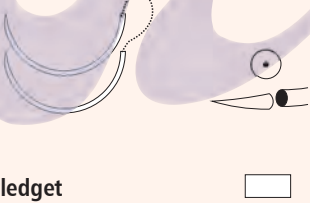
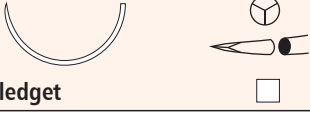

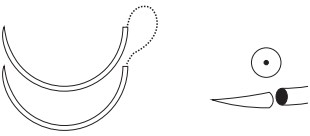

Polisil

Surgical Suture, Braided Polyester, Silicone Coated (PET) Nonabsorbable, Synthetic

Needle Length and description	Product No	USP EP	Length (cm)	Unit Pcs	Color
25 mm					
1/2 Round Body, Taper Point 	PS3727	2/0 3,0	75	12	Green
	PS4191	0 3,5	75	12	Green
1/2 Round Body, Taper Point 	PS3258	3/0 2,0	75	12	Green
	PS3262	3/0 2,0	90	12	Green
	PS3730	2/0 3,0	75	6	5 Green 5 White
	PS3733	2/0 3,0	75	12	Green
	PS3737	2/0 3,0	90	6	5 Green 5 White
	PS3741	2/0 3,0	90	12	Green
25 mm					
1/2 Round Body, Taper Point 3mm x 3mm x 1.5mm Teflon Pledget 	PS3738	2/0 3,0	90	12	Green
	1/2 Round Body, Taper Point 6mm x 3mm x 1.5mm Teflon Pledget 	PS3263	3/0 2,0	90	12
PS3729		2/0 3,0	75	6	5 Green 5 White
PS3732		2/0 3,0	75	12	Green
1/2 Tapercutting 3mm x 3mm x 1.5mm Teflon Pledget 	PS5826	2/0 3,0	90	6	5 Green 5 White
26 mm					
1/2 Round Body, Taper Point 	PS3788	2/0 3,0	75	12	Green
	PS4217	0 3,5	75	12	Green
1/2 Round Body, Taper Point 	PS3322	3/0 2,0	90	12	Green
	PS4221	0 3,5	90	12	Green

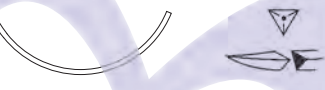

Polisil

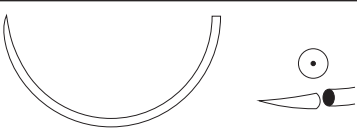
Surgical Suture, Braided Polyester, Silicone Coated (PET) Nonabsorbable, Synthetic

Needle Length and description	Product No	USP EP	Length (cm)	Unit Pcs	Color
30 mm					
1/2 Round Body, Taper Point 	PS3370	3/0 2,0	75	12	Green
	PS3860	2/0 3,0	75	12	Green
	PS4247	0 3,5	75	12	Green
	PS4611	1 4,0	75	12	Green
1/2 Reverse Cutting 	PS4268	0 3,5	75	12	Green
	PS4623	1 4,0	75	12	Green
3/8 Reverse Cutting 	PS3400	3/0 2,0	75	12	Green
	PS3892	2/0 3,0	75	12	Green
35 mm					
3/8 Reverse Cutting 	PS3935	2/0 3,0	75	12	Green
36 mm					
1/2 Round Body, Taper Point 	PS5515	1 4,0	75	12	Green
1/2 Reverse Cutting 	PS5514	0 3,5	75	12	Green
40 mm					
1/2 Round Body, Taper Point 	PS4369	0 3,5	75	12	Green
	PS4714	1 4,0	75	12	Green
	PS5007	2 5,0	90	12	Green
45 mm					
1/2 Round Body, Taper Point 	PS5036	2 5,0	75	12	Green

Polisil

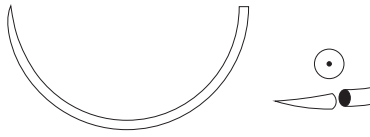
Surgical Suture, Braided Polyester, Silicone Coated (PET) Nonabsorbable, Synthetic

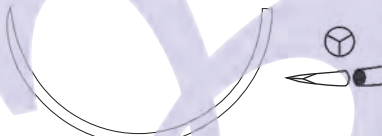
Needle Length and description	Product No	USP EP	Length (cm)	Unit Pcs	Color
50 mm					
1/2 Round Body, Taper Point 	PS4814	1 4,0	75	12	Green
	PS5067	2 5,0	75	12	Green
Straight Reverse Cutting 	PS4049	2/0 3,0	75	12	Green
55 mm					
1/2 Round Body, Taper Point 	PS5181	5 7,0	75	12	Green
1/2 Tapercutting 	PS5173	5 7,0	75	12	Green

Polisil

Surgical Suture, Braided Polyester, Silicone Coated (PET) Nonabsorbable, Synthetic

Non-Needle Suture	Product No	USP EP	Length (cm)	Unit Pcs	Color
17x45 cm					
POLISIL Non-Needle Suture	PS2965	3/0 2,0	17x45	12	Green
	PS3559	2/0 3,0	17x45	12	Green
	PS4150	0 3,5	17x45	12	Green
	PS4560	1 4,0	17x45	12	Green

13x60 cm					
POLISIL Non-Needle Suture	PS2962	3/0 2,0	13x60	12	Green
	PS3554	2/0 3,0	13x60	12	Green

250 cm					
POLISIL Non-Needle Suture	PS4543	1 4,0	250	12	Green

Surgical Sutures

Non-Absorbable

Monotef

Surgical Suture, Polytetrafluoroethylene (PTFE)
Nonabsorbable, Synthetic, Monofilament

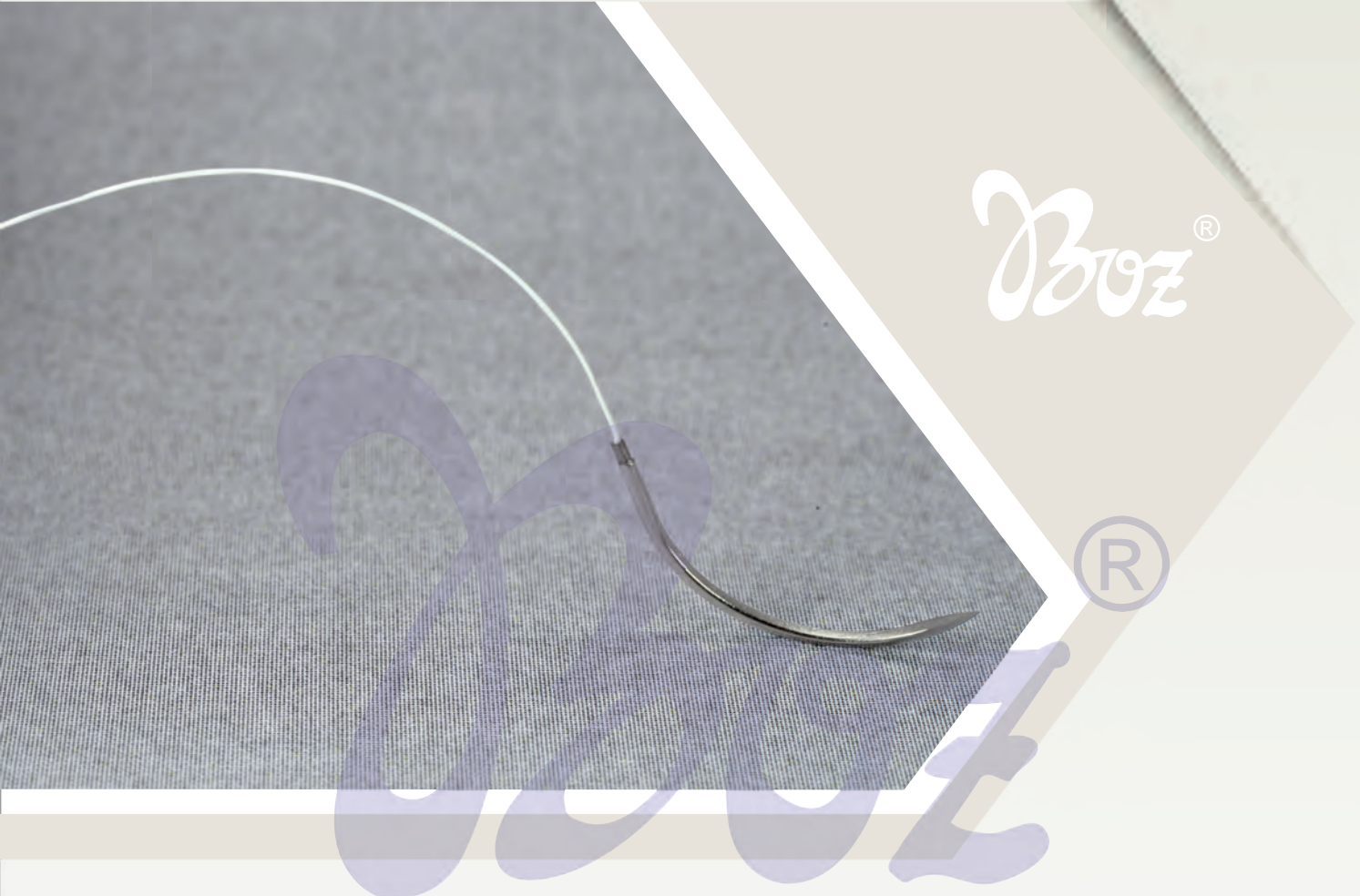

Definition

Synthetic Non-Absorbable

Material

(PTFE) Polytetrafluoroethylene

Coating

No Coating

Structure

Monofilament

Colour

White

Size

EP : 0.5 to 2

USP : 7/0 to 3/0

Tensile Strenght Retention

Permanent

Mass Absorption

Permanent

Sterilization Method

Ethylene Oxide Gas

Main Indication

General Soft Tissue Approximation and/or Ligation

Cardiovascular Surgery

Dental and General Surgeries as

Well as Repair of the Dura Mater

Monotef

Surgical Suture, Polytetrafluoroethylene (PTFE)
Nonabsorbable, Synthetic, Monofilament

Needle Length and description	Product No	USP EP	Length (cm)	Unit Pcs	Color	
8 mm						
1/2 Round Body, Taper Point 280 Micron	 	MT5770	6/0 0,7	45	12	White
8.5 mm						
3/8 Reverse Cutting Premium 280 Micron	 	MT5768	7/0 0,5	55	12	White
10 mm						
3/8 Reverse Cutting Premium 330 Micron	 	MT5767	6/0 0,7	55	12	White
12 mm						
3/8 Reverse Cutting 330 Micron	 	MT1540	6/0 0,7	45	12	White
12.3 mm						
3/8 Reverse Cutting Premium 380 Micron	 	MT5763	5/0 1,0	55	12	White
3/8 Reverse Cutting Premium 430 Micron	 	MT5765	4/0 1,5	75	12	White
13 mm						
3/8 Round Body, Taper Point 380 Micron	 	MT5852	5/0 1,0	75	12	White
3/8 Round Body, Taper Point 430 Micron	 	MT5854	4/0 1,5	75	12	White
3/8 CC Needle 380 Micron	 	MT5853	5/0 1,0	75	12	White
3/8 CC Needle 430 Micron	 	MT5855	4/0 1,5	75	12	White
15 mm						
3/8 Round Body, Taper Point	 	MT5856	3/0 2,0	75	12	White





Monotef

Surgical Suture, Polytetrafluoroethylene (PTFE)
Nonabsorbable, Synthetic, Monofilament

Needle Length and description	Product No	USP EP	Length (cm)	Unit Pcs	Color	
15 mm						
3/8 Reverse Cutting	 	MT5769	6/0 0,7	45	12	White
3/8 CC Needle	 	MT5857	3/0 2,0	75	12	White
16 mm						
3/8 Reverse Cutting	 	MT5771	5/0 1,0	45	12	White
		MT5772	4/0 1,5	45	12	White
3/8 Inside Cutting	 	MT5755	5/0 1,0	45	12	White
16.2 mm						
3/8 Reverse Cutting Premium 430 Micron	 	MT5766	4/0 1,5	75	12	White
17 mm						
1/2 Round Body, Taper Point	 	MT5860	5/0 1,0	75	12	White
1/2 CC Needle	 	MT5861	5/0 1,0	75	12	White
18 mm						
3/8 Reverse Cutting	 	MT5829	3/0 2,0	45	12	White
		MT5558	3/0 2,0	75	12	White
18.7 mm						
3/8 Reverse Cutting 560 Micron	 	MT5764	3/0 2,0	75	12	White
19 mm						
3/8 Reverse Cutting	 	MT5773	4/0 1,5	45	12	White

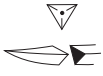
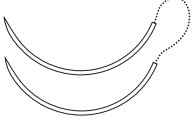
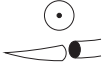
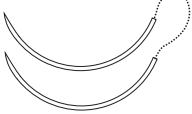
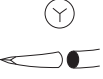
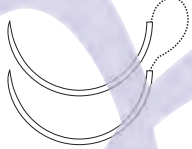
Monotef

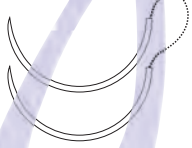
Surgical Suture, Polytetrafluoroethylene (PTFE)
Nonabsorbable, Synthetic, Monofilament

Needle Length and description	Product No	USP EP	Length (cm)	Unit Pcs	Color
20 mm					
3/8 Reverse Cutting  	MT5566	2/0 3,0	75	12	White
25 mm					
3/8 Round Body, Taper Point  	MT5858	2/0 3,0	75	12	White
3/8 CC Needle  	MT5859	2/0 3,0	75	12	White
30 mm					
1/2 Round Body, Taper Point  	MT5862	0 3,5	75	12	White
1/2 CC Needle  	MT5863	0 3,5	75	12	White

Polytef

Surgical Suture, Braided Polyester, PTFE Coated Nonabsorbable, Synthetic

Boz[®]

Definition

Synthetic Non-Absorbable

Material

Polyester Polyethylene Terephthalate (PET)

Coating

PTFE (polytetrafluoroethylene)

Structure

Braided

Colour

Green

Size

EP : 0.5 to 3

USP : 7/0 to 2/0

Tensile Strength Retention

Permanent

Mass Absorption

Permanent

Sterilization Method

Ethylene Oxide Gas

Main Indication

General Soft tissue approximation or ligation



Cardiovascular, Vascular Surgery

Ophthalmic Surgery



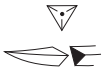

Neurosurgical Surgery

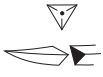

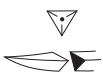
Polytef



Surgical Suture, Braided Polyester, PTFE Coated Nonabsorbable, Synthetic



Needle Length and description			Product No	USP EP	Length (cm)	Unit Pcs	Color
10 mm							
3/8 Reverse Cutting Micropoint 280 Micron			PT5557	7/0 0,5	55	12	Green
3/8 Reverse Cutting Micropoint 330 Micron			PT5556	6/0 0,7	55	12	Green

12 mm							
3/8 Reverse Cutting Micropoint 380 Micron			PT5555	5/0 1,0	55	12	Green

16 mm							
3/8 Reverse Cutting Micropoint			PT5554	5/0 1,0	75	12	Green
3/8 Reverse Cutting Micropoint			PT5553	4/0 1,5	75	12	Green

17 mm							
1/2 Trocar			PT5552	4/0 1,5	75	12	Green

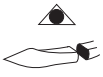
18 mm							
3/8 Reverse Cutting			PT5551	3/0 2,0	75	12	Green

20 mm							
1/2 Trocar Point			PT5550	3/0 2,0	75	12	Green
3/8 Reverse Cutting			PT5565	2/0 3,0	75	12	Green

Monowire

Surgical Stainless Steel Wire Nonabsorbable, Monofilament or Multifilament

Boz[®]

Definition

Non-Absorbable

Material

316L Stainless Steel conforming to
ISO 5832 Part-1

Coating

FEP or PE

Structure

Monofilament or Multifilament

Colour

Metallic, Blue, Transperant, Orange

Size

EP : 0.7 to 10
USP : 6/0 to 8

Tensile Strenght Retention

Permanent

Mass Absorption

Permanent











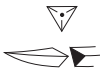



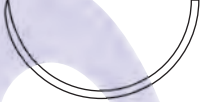

Sterilization Method

Ethylene Oxide Gas

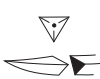

Main Indication

Sternum Closure
Orthopaedics
Abdominal wound closure
Hernia repair

Monowire Surgical Stainless Steel Wire Nonabsorbable, Monofilament or Multifilament

Needle Length and description	Product No	USP EP	Length (cm)	Unit Pcs	Color	
30 mm						
1/2 Reverse Cutting	 	MW3881	2/0 3,0	75	12	Mono
40 mm						
1/2 Reverse Cutting	 	MW4743	1 4,0	4 X 45	12	Mono
1/2 Tapercutting	 	MW4707	1 4,0	75	12	Mono
48 mm						
1/2 Reverse Cutting	 	MW5056	2 5,0	4 X 45	12	Mono
		MW5057	2 5,0	45	12	Mono
1/2 Reverse Cutting Heavy	 	MW5126	3 6,0	75	12	Mono
		MW5153	4 6,0	75	12	Mono
1/2 Tapercutting Heavy	 	MW5163	5 7,0	45	12	Mono
		MW5198	6 8,0	45	12	Mono
1/2 Tapercutting Heavy, Rotating	 	MW5146	4 6,0	45	12	Mono
55 mm						
1/2 Reverse Cutting Heavy	 	MW5131	3 6,0	75	12	Mono
1/2 Reverse Cutting Rotating	 	MW5087	2 5,0	75	12	Mono
1/2 Reverse Cutting Heavy, Rotating	 	MW5156	4 6,0	2 X 75	12	Mono
		MW5187	5 7,0	45	12	Mono

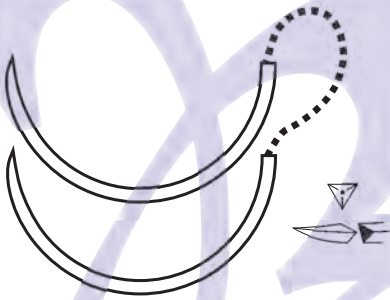
Monowire Surgical Stainless Steel Wire Nonabsorbable, Monofilament or Multifilament

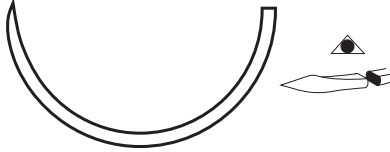
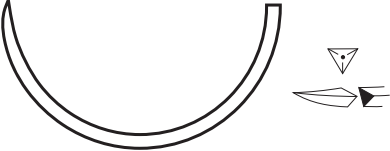
Needle Length and description	Product No	USP EP	Length (cm)	Unit Pcs	Color
55 mm					
1/2 Reverse Cutting Heavy, Rotating 	MW5188	5 7,0	2 X 45	12	Mono
	MW5189	5 7,0	4 X 45	12	Mono
	MW5190	5 7,0	75	12	Mono
	MW5191	5 7,0	2 X 75	12	Mono
	MW5192	5 7,0	4 X 75	12	Mono
	MW5206	6 8,0	4 X 75	12	Mono
	MW5205	6 8,0	75	12	Mono
1/2 Reverse Cutting Heavy, Rotating 	MW5193	5 7,0	75	12 	Mono
1/2 Trocar Point Heavy, Rotating 	MW5777	5 7,0	4 X 45	12	Mono
	MW5179	5 7,0	75	12	Mono
	MW5180	5 7,0	2 X 75	12	Mono
	MW5203	6 8,0	75	12	Mono
	MW5204	6 8,0	2 X 75	12	Mono
	MW5208	7 9,0	75	12	Mono
	MW5209	7 9,0	2 X 75	12	Mono
57 mm					
1/2 Reverse Cutting Heavy, Rotating 	MW5195	5 7,0	75	12	Mono
	MW5196	5 7,0	2 X 75	12	Mono

Tempowire

Surgical Stainless Steel Wire Nonabsorbable, Multifilament



BOZ[®]

BOZ[®]

Definition

Non-Absorbable

Material

316L Stainless Steel conforming to
(ISO 5832 Part-1)

Coating

FEP, Polyethylene

Structure

Braided, Twisted

Colour

Blue, Transparent, Orange

Size

EP : 2 to 3.5

USP : 3/0 to 0

Tensile Strength Retention

Permanent

Mass Absorption

Permanent



Sterilization Method

Ethylene Oxide Gas





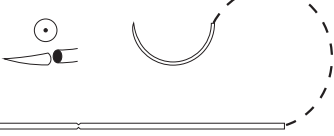
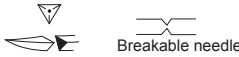
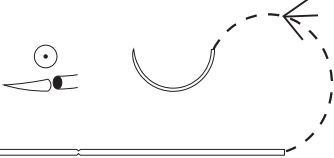
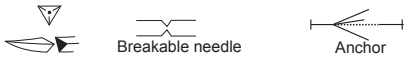
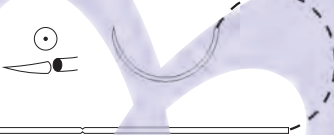

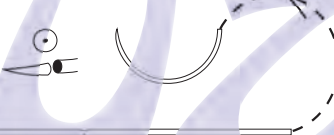
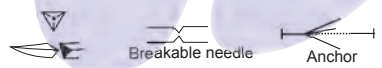
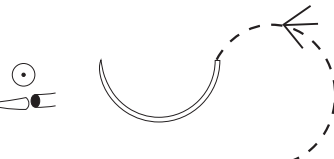
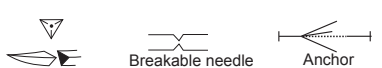
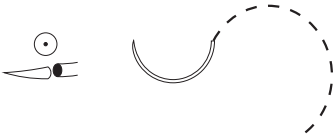
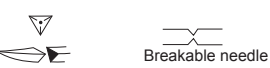

Main Indication

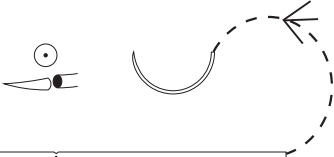
Cardiac Surgery

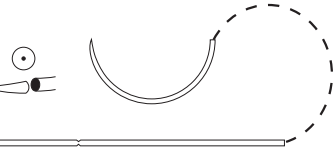
Tempowire Surgical Stainless Steel Wire Nonabsorbable, Multifilament

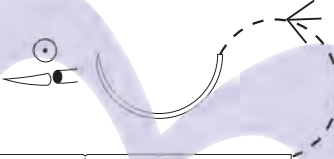
Needle Length and description	Product No	USP EP	Length (cm)	Unit Pcs	Color
17 mm					
1/2 Round Body, Taper Point 	TW3068	3/0 2,0	60	12	PE-Blue
63 mm Straight Reverse Cutting  Breakable needle					
1/2 Round Body, Taper Point 	TW5918	3/0 2,0	60	12	PE-Blue
63 mm Straight Reverse Cutting  Breakable needle Anchor					
22 mm					
1/2 Round Body, Taper Point 	TW3194	3/0 2,0	60	12	PE-Blue
63 mm Straight Reverse Cutting  Breakable needle Zig - Zag type					
1/2 Round Body, Taper Point 	TW5874	3/0 2,0	60	12	PE-Blue
63 mm Straight Reverse Cutting  Breakable needle Anchor					
25 mm					
1/2 Round Body, Taper Point 	TW5869	2/0 3,0	60	12	PE-Blue
60 mm Straight Reverse Cutting  Breakable needle Anchor					
26 mm					
1/2 Round Body, Taper Point 	TW3327	3/0 2,0	60	12	PE-Blue
63 mm Straight Reverse Cutting  Breakable needle					

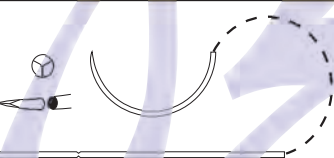
Tempowire Surgical Stainless Steel Wire Nonabsorbable, Multifilament

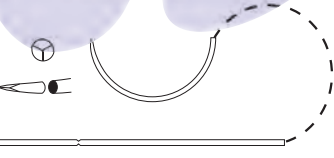
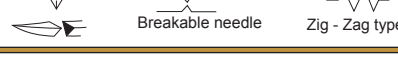
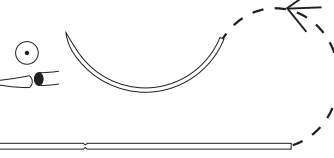
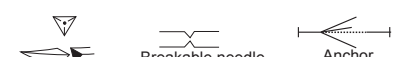
Needle Length and description	Product No	USP EP	Length (cm)	Unit Pcs	Color
26 mm					
1/2 Round Body, Taper Point 	TW5877	3/0 2,0	60	12	PE-Blue
85 mm Straight Reverse Cutting  Breakable needle Anchor					
1/2 Round Body, Taper Point 	TW3326	3/0 2,0	60	12	PE-Blue
63 mm Straight Reverse Cutting  Breakable needle Zig - Zag type	TW4208	0 3,5	60	12	PE-Blue
1/2 Round Body, Taper Point 	TW5576	3/0 2,0	60	12	PE-Blue
63 mm Straight Reverse Cutting  Breakable needle Anchor					
1/2 Tapercutting 	TW3296	3/0 2,0	60	12	PE-Blue
63 mm Straight Reverse Cutting  Breakable needle	TW4204	0 3,5	60	12	FEP
1/2 Tapercutting 	TW3297	3/0 2,0	60	12	PE-Blue
63 mm Straight Reverse Cutting  Breakable needle Zig - Zag type					
3/8 Round Body, Taper Point 	TW5907	3/0 2,0	60	12	PE-Blue
63 mm Straight Reverse Cutting  Breakable needle Anchor					

▶ PTFE pledget

(Accessory for sutures)



Boz®

Surgical Pledget PTFE

Description

Boz® Pledgets are pre-cut pieces from a sheet of polytetra-fluoroethylene (PTFE) non-woven fabric that is used to cushioning the load of the suture against host tissue. Pledgets are indicated as sterile, single use, implantable devices.

Indications

To buttress sutures in cardiovascular surgery.











Absorbability-Tissue Reaction

Non-Absorbable. It's inert to body fluids and enzymes.

Boz®

web : www.boztibbi.com
email: boz@boztibbi.com

Teflon Pledgets Firm, White, Non-Woven, Non-Absorbable

Product No	Dimensions	Unit / Pcs
TPFE01	 6x3x1.5mm	6 pledgets per 1 pack
TPFE02	 6x3x1.5mm	5 pledgets per 1 pack
TPFE03	 6x3x1.5mm	10 pledgets per 1 pack
TPFE04	 7x3x1.5mm	6 pledgets per 1 pack
TPFE10	 3x3x1.5mm	10 pledgets per 1 pack
TPFE11	 3x3x1.5mm	5 pledgets per 1 pack
TPFE20	 6x4x1.5mm	10 pledgets per 1 pack
TPFE28	 6x8x1.5mm	4 pledgets per 1 pack
TPFE30	 6x10x1.5mm	5 pledgets per 1 pack
TPFE50	 6x6x1.5mm	10 pledgets per 1 pack
TPFE60	 7x3x1.5mm	10 pledgets per 1 pack

**Soft and firm consistencies in several geometries and sizes.
and in any required size shape

ABSORBABLE HAEMOSTATS



Boz Tibbi Malz.San. Tic. A.Ş.

Driven by Surgical Need,
Committed to Innovative
Solution

REOXCEL

Oxidized Regenerated Cellulose (ORC)

REOXCEL - Sigma Knit

Oxidized Regenerated Cellulose (ORC)

REOXCEL - Fibril

Oxidized Regenerated Cellulose (ORC)

ZEOCEL

Oxidized Cellulose (OC)

www.boztibbi.com
boz@boztibbi.com

REOXCEL

Absorbable Haemostat,
Oxidized Regenerated Cellulose (ORC)

Reliable Performance

Safe Haemostasis
Effective Against Bacteria

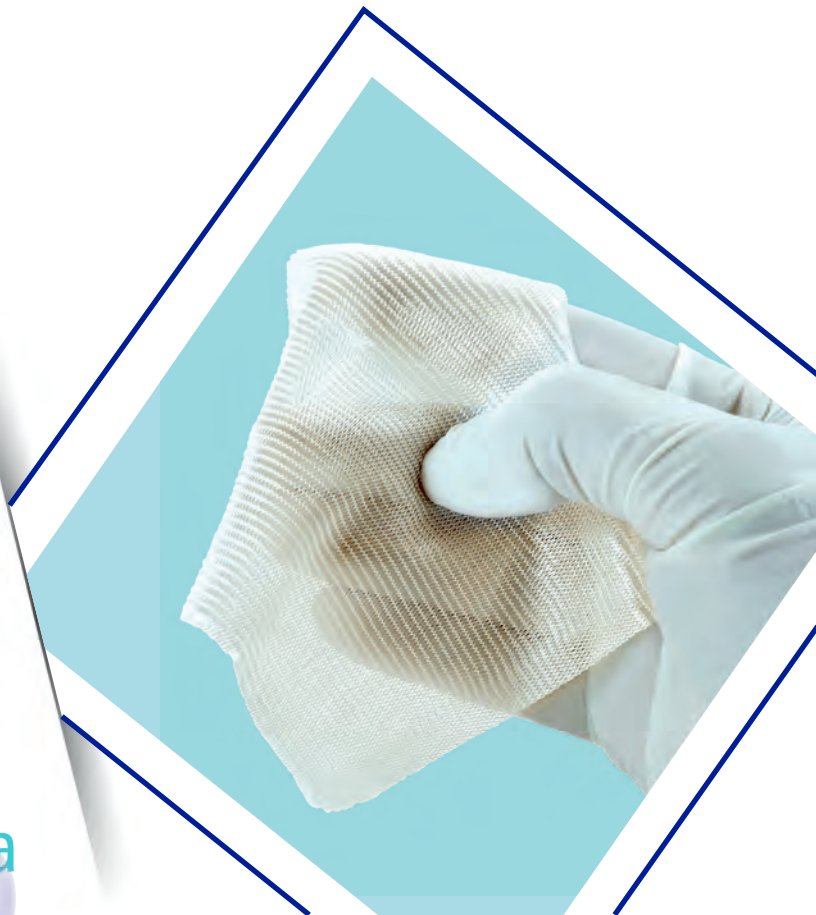

- ▶ Light knit formation covers uneven tissue
- ▶ Applicable on wide range of operations



DESCRIPTION

REOXCEL Absorbable Haemostat is a sterile haemostatic preparation available in the flat form with textile structure and made of Oxidized Regenerated Cellulose (ORC) (polyanhydro glucuronic acid). REOXCEL Absorbable Haemostat complies with the requirements of the United States Pharmacopoeia for "Oxidized Regenerated Cellulose". REOXCEL Absorbable Haemostat does not contain any animal or collagen additives. REOXCEL Absorbable Haemostat can be sutured and cut without fraying. Its structure is stable and should be stored at controlled room temperature. The fabric is pale yellow and has a faint, caramel-like aroma. Although a slight discoloration may occur with time, this does not affect its performance.

ACTIONS

REOXCEL Absorbable Haemostat can be laid on, held against, closed exactly or sutured to a bleeding surface. REOXCEL Absorbable Haemostat is applied as dry. Action mechanism of REOXCEL Absorbable Haemostat is independent from blood coagulation mechanism of the body. REOXCEL Absorbable Haemostat forms a brownish or black gelatinous mass which aids clot formation in 3-4 minutes when it contacts with blood. This gelatinous mass acts as a physical matrix to which platelets can adhere. With platelet aggregation and formation of platelet-fibrin plug, haemostasis occurs. REOXCEL Absorbable Haemostat is absorbed from the sites of implantation without tissue reaction when it is used properly in minimal amounts. Absorption depends on; tissue type, haemostat amount used and saturation degree of blood. It is completely absorbed in 7-14 days. REOXCEL Absorbable Haemostat has been shown to be bactericidal in vitro against 40 types of Gr(+) (gram positive) and Gr (-) (gram negative) microorganisms including those of.

Product Code	Description of Product	Unit of Sale
RX0502	1,25cm x 5cm	12 Sachets per box
RX1001	2,5cm x 2,5cm	12 Sachets per box
RX1002	2,5cm x 5cm	12 Sachets per box
RX1003	2,5cm x 7,5cm	12 Sachets per box
RX1063	2,5cm x 9cm	12 Sachets per box
RX2003	5cm x 7,5cm	12 Sachets per box
RX2004	5cm x 10cm	12 Sachets per box
RX2014	5cm x 35cm	12 Sachets per box
RX3004	7,5cm x 10cm	12 Sachets per box
RX4004	10cm x 10cm	12 Sachets per box
RX4008	10cm x 20cm	12 Sachets per box
RX6009	15cm x 23cm	12 Sachets per box

Product Code	Description of Product	Unit of Sale
RX0502X	1,25cm x 5cm	10 Sachets per box
RX1001X	2,5cm x 2,5cm	10 Sachets per box
RX1002X	2,5cm x 5cm	10 Sachets per box
RX2003X	5cm x 7,5cm	10 Sachets per box
RX2004X	5cm x 10cm	10 Sachets per box
RX2014X	5cm x 35cm	10 Sachets per box
RX3004X	7,5cm x 10cm	10 Sachets per box
RX4004X	10cm x 10cm	10 Sachets per box
RX4008X	10cm x 20cm	10 Sachets per box
RX6009X	15cm x 23cm	10 Sachets per box



REOXCEL - Sigma Knit

Absorbable Haemostat,
Oxidized Regenerated Cellulose (ORC)

**Unmatched
Stability Against
Heavier Bleeding**
Safe Haemostasis
Effective Against Bacteria



- ▶ Dense knit web, sustain surgical suture use
- ▶ Ideal web structure where wrapping is required



DESCRIPTION

REOXCEL-Sigma Knit Absorbable Haemostat is a sterile haemostatic preparation available in the flat form with textile structure and made of Oxidized Regenerated Cellulose (ORC) (polyanhydro glucuronic acid). REOXCEL-Sigma Knit Absorbable Haemostat complies with the requirements of the United States Pharmacopoeia for "Oxidized Regenerated Cellulose". REOXCEL-Sigma Knit Absorbable Haemostat does not contain any animal or collagen additives. REOXCEL-Sigma Knit Absorbable Haemostat can be sutured and cut without fraying. Its structure is stable and should be stored at controlled room temperature. The fabric is pale yellow and has a faint, caramel-like aroma. Although a slight discoloration may occur with time, this does not affect its performance.

ACTIONS

REOXCEL-Sigma Knit Absorbable Haemostat can be laid on, held against, closed exactly or sutured to a bleeding surface. REOXCEL-Sigma Knit Absorbable Haemostat is applied as dry. Action mechanism of REOXCEL-Sigma Knit Absorbable Haemostat is independent from blood coagulation mechanism of the body. REOXCEL-Sigma Knit Absorbable Haemostat forms a brownish or black gelatinous mass which aids clot formation in 3-4 minutes when it contacts with blood. This gelatinous mass acts as a physical matrix to which platelets can adhere. With platelet aggregation and formation of platelet-fibrin plug, haemostasis occurs. REOXCEL-Sigma Knit Absorbable Haemostat is absorbed from the sites of implantation without tissue reaction when it is used properly in minimal amounts. Absorption depends on; tissue type, haemostat amount used and saturation degree of blood. It is completely absorbed in 7-14 days. REOXCEL-Sigma Knit Absorbable Haemostat has been shown to be bactericidal in vitro against 40 types of Gr(+) (gram positive) and Gr (-) (gram negative) microorganisms including those of.

Product code	Description of Product	Unit of Sale
RK1001	2,6cm x 2,6cm	12 Sachets per box
RK1003	2,6cm x 10cm	12 Sachets per box
RK2003	5cm x 7,5cm	12 Sachets per box
RK3004	7,6cm x 10,2cm	12 Sachets per box
RK6009	15,2cm x 23cm	10 Sachets per box

Product code	Description of Product	Unit of Sale
RK1001X	2,6cm x 2,6cm	10 Sachets per box
RK1003X	2,6cm x 10cm	10 Sachets per box
RK2003X	5cm x 7,5cm	10 Sachets per box
RK3004X	7,6cm x 10,2cm	10 Sachets per box

REOXCEL - Fibril

Absorbable Haemostat,
Oxidized Regenerated Cellulose (ORC)

All-Round Performance

Safe Haemostasis
Effective Against Bacteria



- ▶ Thin layers of web adapt easily to uneven and hard to
- ▶ Moistened light layer web allows bipolar cauter use
- ▶ Range of diverse forms; Light single layers, Roll, Pad, Tufts

DESCRIPTION

REOXCEL FIBRIL Absorbable Haemostat is a sterile haemostatic preparation available in the fibrous form and made of Oxidized Regenerated Cellulose (ORC) (polyanhydroglucuronic acid). REOXCEL FIBRIL Absorbable Haemostat complies with the requirements of the United States Pharmacopoeia for "Oxidized Regenerated Cellulose". REOXCEL FIBRIL Absorbable Haemostat does not contain any animal or collagen additives. REOXCEL FIBRIL Absorbable Haemostat can be cut without fraying. Its structure is stable and should be stored at controlled room temperature. It is pale yellow and has a faint, caramel-like aroma. Although a slight discoloration may occur with time, this does not affect its performance. Under favour of its fibrous form surgeon can grasp with forceps any amount of REOXCEL FIBRIL Absorbable Haemostat needed to achieve haemostasis at a particular bleeding site. This provides surgeon to reach irregularly shaped bleeding sites. It is easy to pull the desired amount of REOXCEL FIBRIL Absorbable Haemostat and the group of selected fibres continue to cohere to one another. It does not disperse over the operative site unwantedly.

ACTIONS

REOXCEL FIBRIL Absorbable Haemostat can be laid on, held against, closed exactly to a bleeding surface. REOXCEL FIBRIL Absorbable Haemostat is applied as dry. Action mechanism of REOXCEL FIBRIL Absorbable Haemostat is independent from blood coagulation mechanism of the body. REOXCEL FIBRIL Absorbable Haemostat forms a brownish or black gelatinous mass which aids clot formation in 3-4 minutes when it contacts with blood. This gelatinous mass acts as a physical matrix to which platelets can adhere. With platelet aggregation and formation of platelet-fibrin plug, haemostasis occurs. REOXCEL FIBRIL Absorbable Haemostat is absorbed from the sites of implantation without tissue reaction when it is used properly in minimal amounts. Absorption depends on; tissue type, haemostat amount used and saturation degree of blood. It is completely absorbed in 7-14 days. REOXCEL FIBRIL Absorbable Haemostat has been shown to be bactericidal in vitro against 40 types of Gr(+) (gram positive) and Gr(-) (gram negative) microorganisms including those of.

Product Code	Description of Product	Unit of Sale
RF1002	2.6cm x 5.1cm	10 Sachets per box
RF2003	5cm x 7.5cm	10 Sachets per box
RF2004	5.1cm x 10.2cm	10 Sachets per box
RF4004	10.2cm x 10.2cm	10 Sachets per box

ZEOCEL

Absorbable Haemostat,
Oxidized Cellulose (OC)

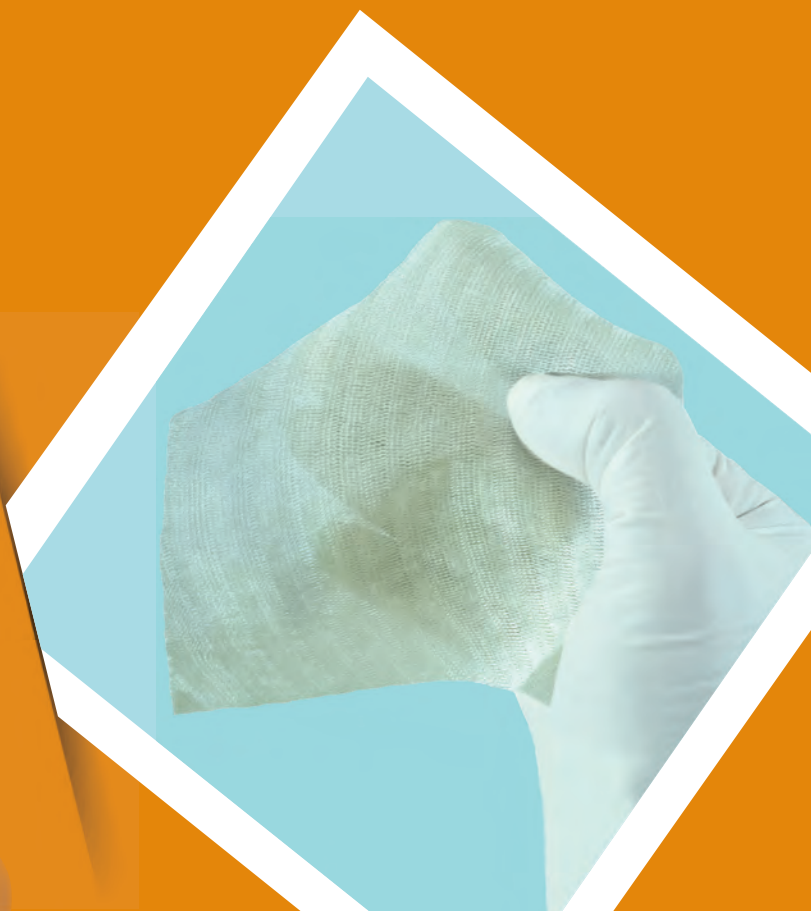

Safe Haemostasis Effective Against Bacteria

DESCRIPTION

ZEOCEL Absorbable Haemostat is a woven sterile hemostatic agent formed of oxidized cellulose (OC) (polyanhydro glucuronic acid). It has been manufactured from alpha grade cotton. Agent is a pale yellow material and has a caramel like smell. As it is stored in controlled room temperature, there might be a slight change in color in time but this does not effect the performance of the material. ZEOCEL Absorbable Haemostat complies with the requirements of the United States Pharmacopoeia for "Oxidized Cellulose". ZEOCEL Absorbable Haemostat does not contain any animal or collagen additives.

ACTIONS

ZEOCEL Absorbable Haemostat can be applied to bleeding surface in different forms. The haemostatic agent material can be closed exactly, pressured against or sutured to the desired usage area. ZEOCEL Absorbable Haemostat should be used as dry. After the application of the material to the bleeding surface, haemostatic agent will form a black gelatin like mass. The gelatin like mass will aid haemostasis process by allowing the platelet aggregation and formation of platelet-fibrin plug. The coagulation will be achieved in 3-4 minutes after ZEOCEL's contact with the bleeding area. When ZEOCEL Absorbable Haemostat is used only as needed, it will be absorbed from the site of usage without tissue reaction. Absorption of the haemostatic agent from the used site depends on the amount of haemostatic agent used, tissue type and blood saturation degree. The material will be fully absorbed in 7-14 days.

ZEOCEL Absorbable Haemostat has been shown to be bactericidal in vitro against 40 types of Gr(+) (gram positive) and Gr(-) (gram negative) microorganisms including those of.

Product code	Description of Product	Unit of Sale
ZC0502	1.25cm x 5cm	12 Sachets per box
ZC1001	2.5cm x 2.5cm	12 Sachets per box
ZC1002	2.5cm x 5cm	12 Sachets per box
ZC2003	5cm x 7.5cm	12 Sachets per box
ZC2004	5cm x 7cm	12 Sachets per box
ZC2014	5cm x 35cm	12 Sachets per box
ZC3004	7.5cm x 10cm	12 Sachets per box
ZC4004	10.2cm x 10.2cm	12 Sachets per box
ZC4008	10cm x 20cm	12 Sachets per box
ZC6009	15cm x 23cm	12 Sachets per box

Product code	Description of Product	Unit of Sale
ZC0502X	1.25cm x 5cm	10 Sachets per box
ZC1001X	2.5cm x 2.5cm	10 Sachets per box
ZC1002X	2.5cm x 5cm	10 Sachets per box
ZC2003X	5cm x 7.5cm	10 Sachets per box
ZC2004X	5cm x 7cm	10 Sachets per box
ZC2014X	5cm x 35cm	10 Sachets per box
ZC3004X	7.5cm x 10cm	10 Sachets per box
ZC4004X	10.2cm x 10.2cm	10 Sachets per box
ZC4008X	10cm x 20cm	10 Sachets per box
ZC6009X	15cm x 23cm	10 Sachets per box

Creativea

i d e a s
s u g g e s t i o n s



Boz[®]

Boz Tibbi Malz.San. Tic. A.Ş.

Specialist Products



Microsurgery
Products



Retention
Padded Plates



Polypropylene
Button



Polypropylene
Locking Button



Polypropylene Bead
Aluminium Ring

www.boztibbi.com
boz@boztibbi.com

Surgical Indications

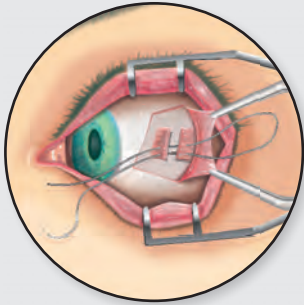

Eye, Hand, Plastic, Brain and Nerve operations.

Needle

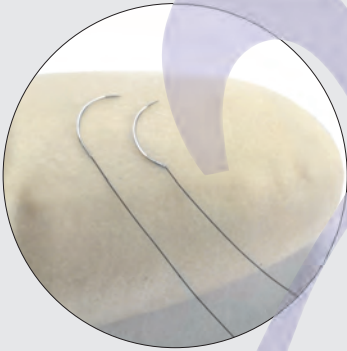

Hardened stainless steel for custom purposes, no bending, no breaking, microscopically inspected available in taperpoint, spatulated, lancet.

Thread

Excellent resistance, easy tying, safe knot, non-capillary, extremely smooth surface, just the right elasticity. Virgin Silk, Nylon, Polypropylene, Polyvinylidene fluoride, Polyglycolic acid.

Packaging



Keeps suture material free of tangles. Protects the sharpness of needle. Provides double armed suture for single arming by locating the mid-point. Stores the second suture until needed. Provides a disposable pad for needle count.

Description

For the treatment and prevention of abdominal ruptures.

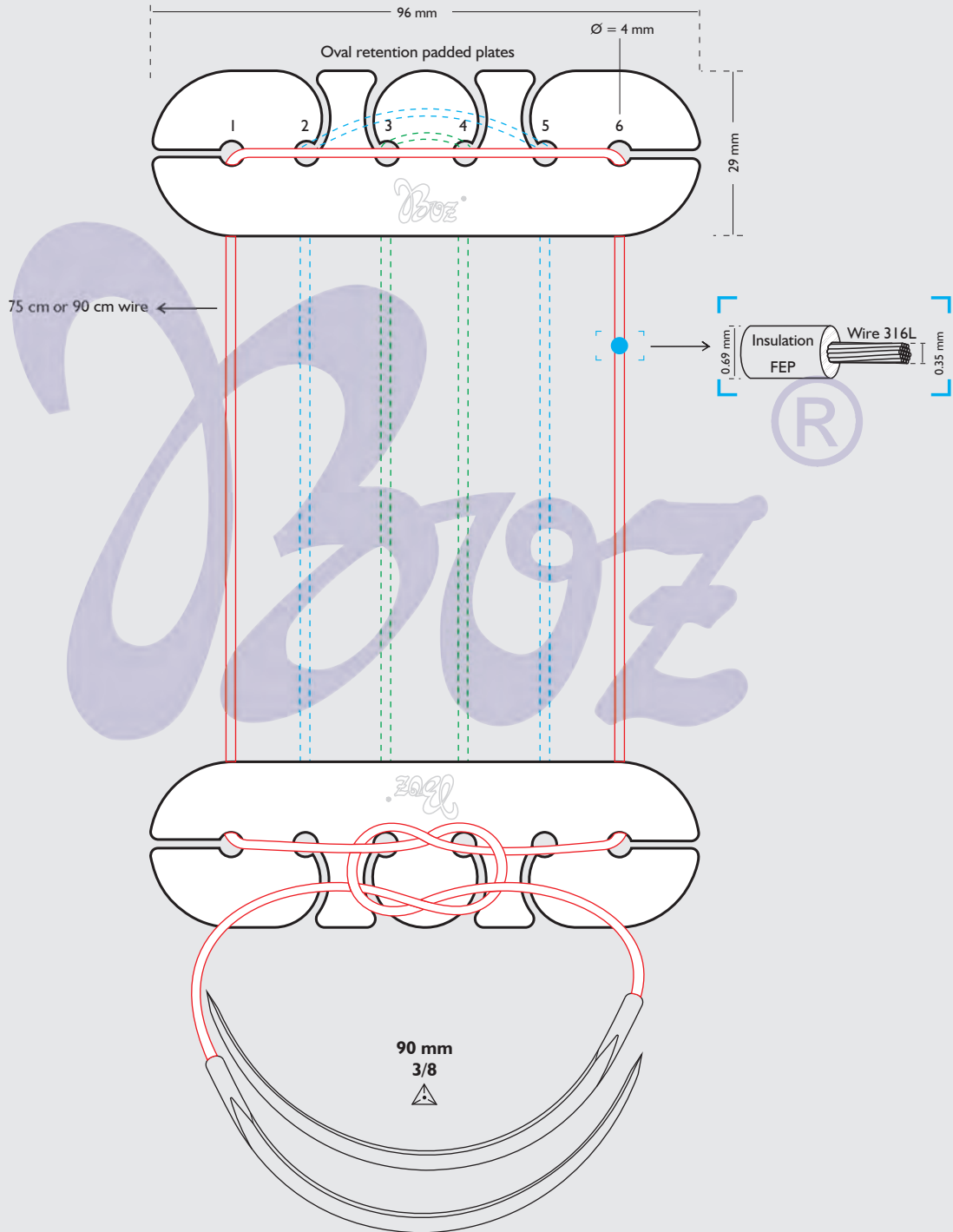

Description

Polypropylene button, White,
Ø = 12 mm, thickness.....mm, Ø hole =.....mm.



Indications

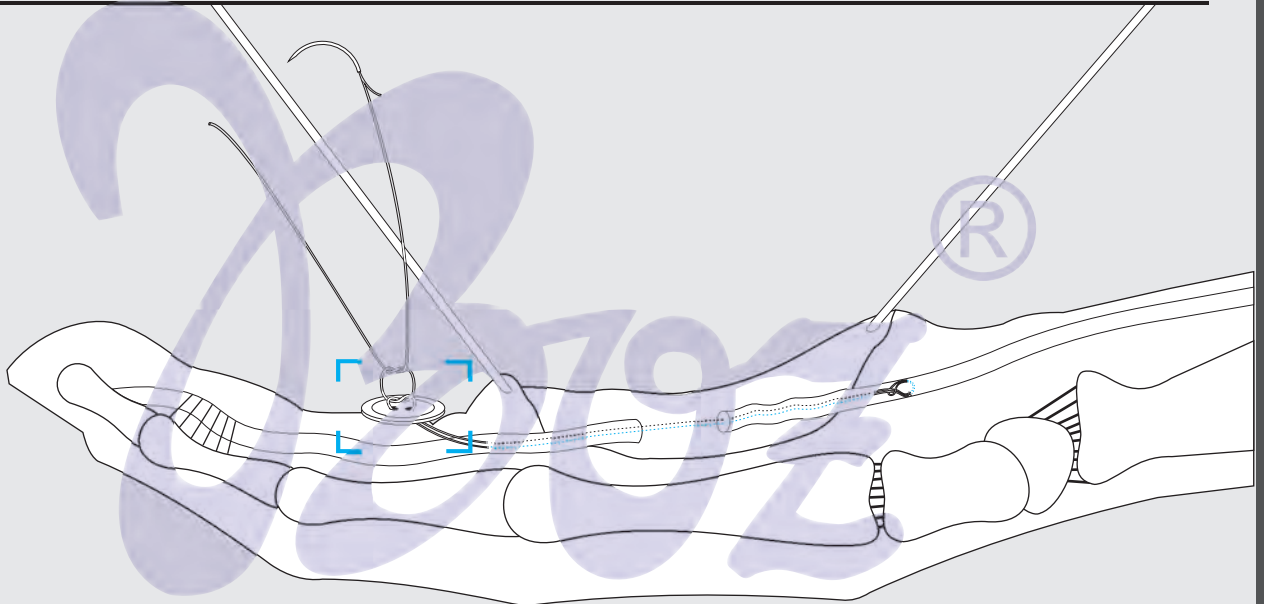

Polypropylene button in the Boz tendon repair kit is intended to be used in Bunnell Technique in tendon surgery to act as knot-fastening support over the skin to avoid suture cut and to offer pull-out suture opportunity after healing.

Absorbability-Tissue Reaction

Nonabsorbable, skin contact.

Description

Polypropylene locking button.

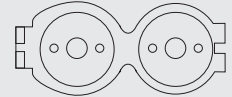
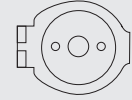

27mm x 12mm

Indications



The Boz polypropylene locking button is intended to be used as anchor device instead of knot in subcuticular suturing .

Absorbability-Tissue Reaction

Nonabsorbable, skin surface application.

Description

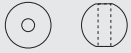

Polypropylene Bead, White.
Ø = 6 mm, Ø hole = 1.7 mm,



Aluminium Ring
Ø = 3 mm, h = 3 mm, Ø hole = 1.7 mm,

Indications

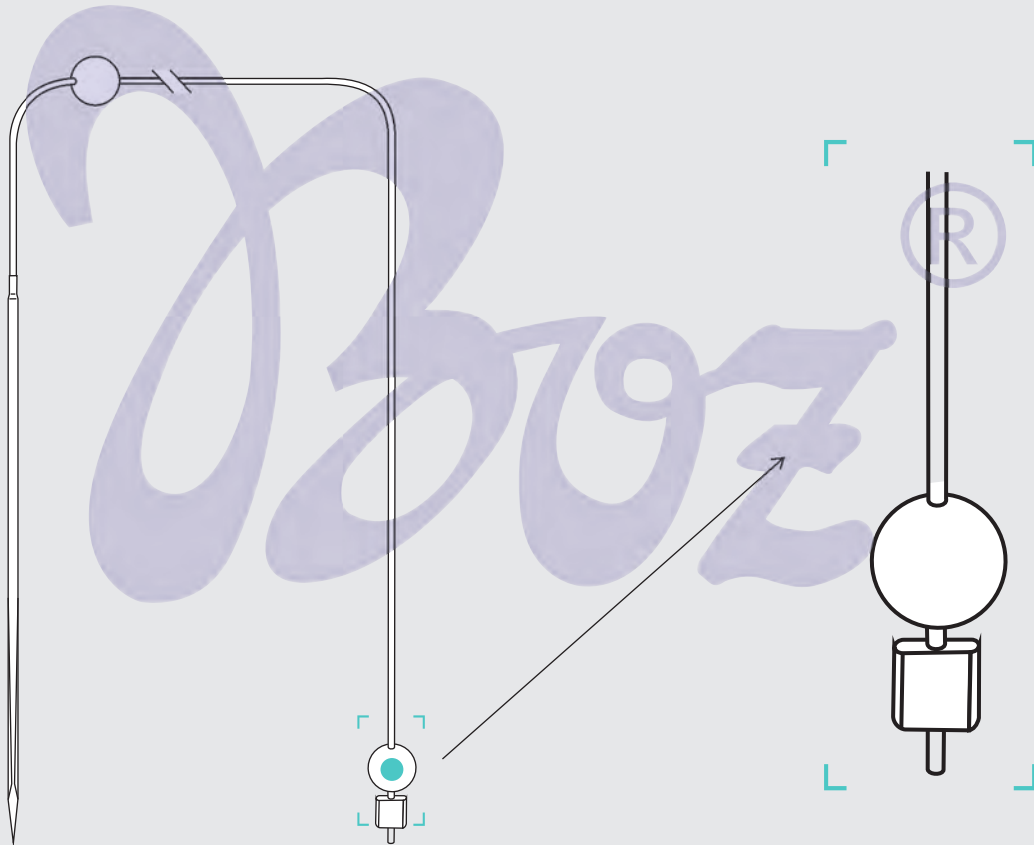

Absorbability-Tissue Reaction

Nonabsorbable, skin contact.

Boz®

Boz Medical Device Industry and Trade Inc.

Sağlık Mahallesi Sağlık Sokak No:33/5 Sıhhiye/Ankara/TÜRKİYE

Tel: + 90 (312) 254 03 40 Fax: +90 (312) 254 03 49

web: www.boztibbi.com - email: boz@boztibbi.com

GenelKatalog-rev-00-26-10-2017

Boz Grafik